











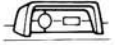

















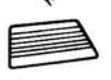





















# SYSTEM INDEX

LAND CRUISER (W/G)

(Location No. 1 to 43)

SYSTEMS	LOCATION	SYSTEMS	LOCATION
ABS (Anti-Lock Brake System)	 41-3	Light Auto Turn Off	 40-4
Accessory Meter	 20-3	Light Reminder	 24-3
Air Conditioner, Cooler and Heater	 <small>30-4 (Push SW Type) 34-4 (Manual Dual A/C Type) 38-4 (Manual Single A/C Lever SW Type)</small>	Moon Roof	 19-2
Auto Antenna	 <small>13-2 (Australia) 13-4 (Ex. Australia)</small>	Power Seat	 19-3
Automatic Transmission Indicator	 21-2	Power Source	 1 ~ 30, 34, 36 ~ 41-1
Back-Up Light	 21-3	Power Window	 15-3
Charging	 2-3	PPS (Progressive Power Steering)	 5-3
Cigarette Lighter	 24-3	Radio and Player	 <small>26-3 (w/o CD Player) 26-5 (w/ CD Player)</small>
Clock	 24-2	Rear Air Conditioner	 <small>33-3 (Auto) 35-4 (Manual)</small>
Combination Meter	 28-4	Rear Fog Light	 14-3
Condenser Fan	 34-2	Rear Window Defogger	 18-2
Cool/Ice Box	 33-6	Rear Wiper and Washer	 <small>17-3 (1HZ, 1HD-T) 38-4 (1FZ-FE, 1FZ-F)</small>
Cruise Control	 23-3	Remote Control Mirror	 20-2
ECT (Electronic Controlled Transmission)	 39-3	Satellite Navigation	 <small>3-2 (Australia)</small>
Emission Control	 <small>37-2 (1FZ-FLHD) 37-3 (1FZ-FRHD)</small>	Seat Belt Warning	 21-4
Engine Control	 27-4	Seat Heater	 18-4
Front Wiper and Washer	 <small>17-2 (1HZ, 1HD-T) 38-2 (1FZ-FE, 1FZ-F)</small>	Starting	 1-3
Fuel Heater	 19-5	Stop Light	 24-4
Fuel Tank Changeover	 29-6	Sub Fuel Tank	 40-2 (1FZ-FE)
Glow Plug	 4-3	Taillight and Illumination	 25-4
Headlight Beam Level Control	 6-3	Theft Deterrent and Door Lock	 16-3
Headlight Cleaner	 3-4	Turn Signal and Hazard Warning Light	 12-2
Headlight	 <small>7-2 (w/ Daytime Running Light) 8-2 (LHD in Europe w/o Daytime Running Light) 9-2 (LX) 10-2 (Ex. LHD in Europe)</small>	Winch	 5-4
Horn	 12-4	4WD	 22-3
Ignition	 <small>37-4 (1FZ-F)</small>	12-24 Volt Switchover System	 1-2
Interior Light	 11-3	Connector Joining Wire Harness and Wire Harness	42, 43

# LAND CRUISER (W/G) ELECTRICAL WIRING DIAGRAM

# LAND CRUISER (W/G) 1

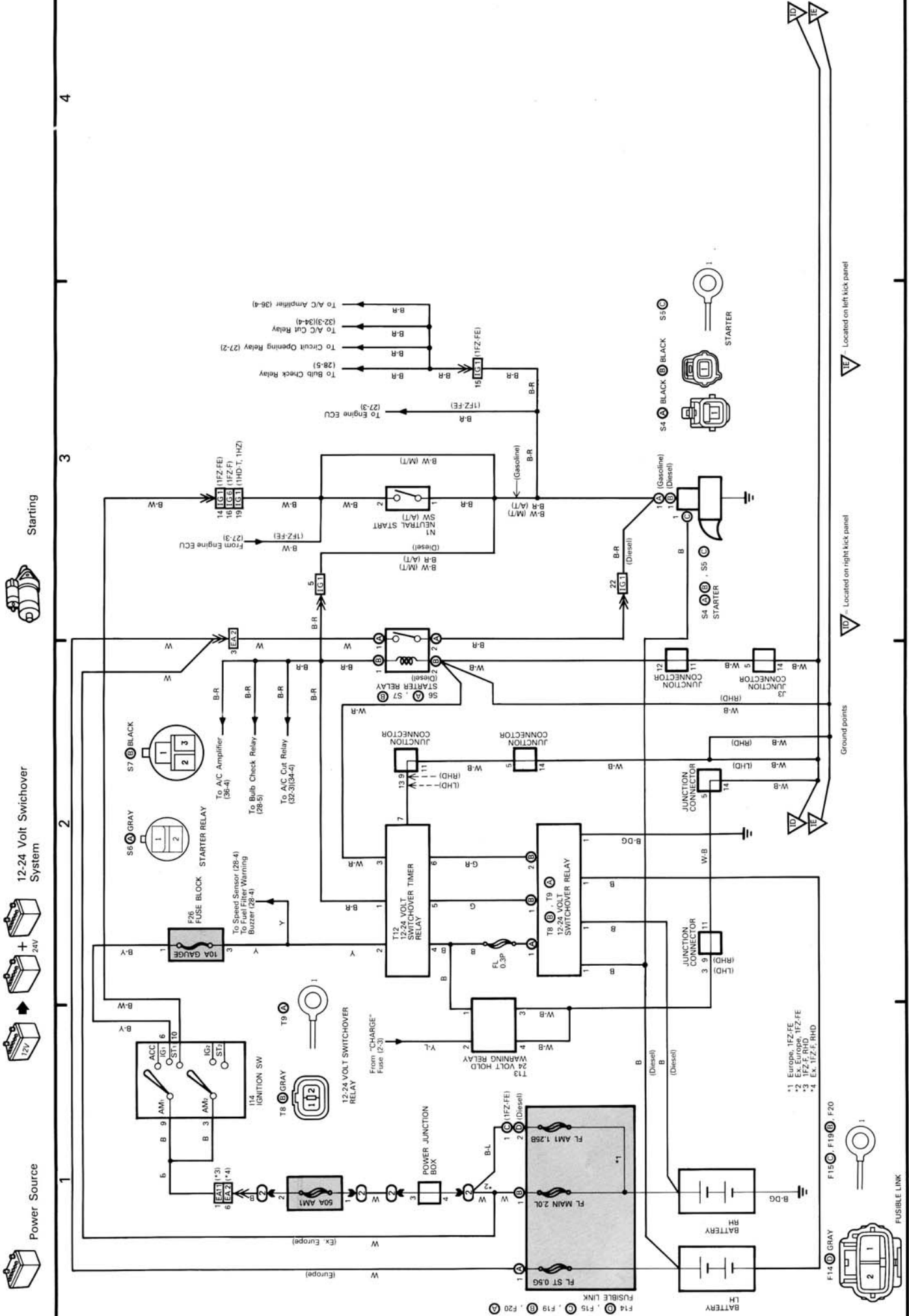

# 2 LAND CRUISER (W/G)



Power Source



Charging

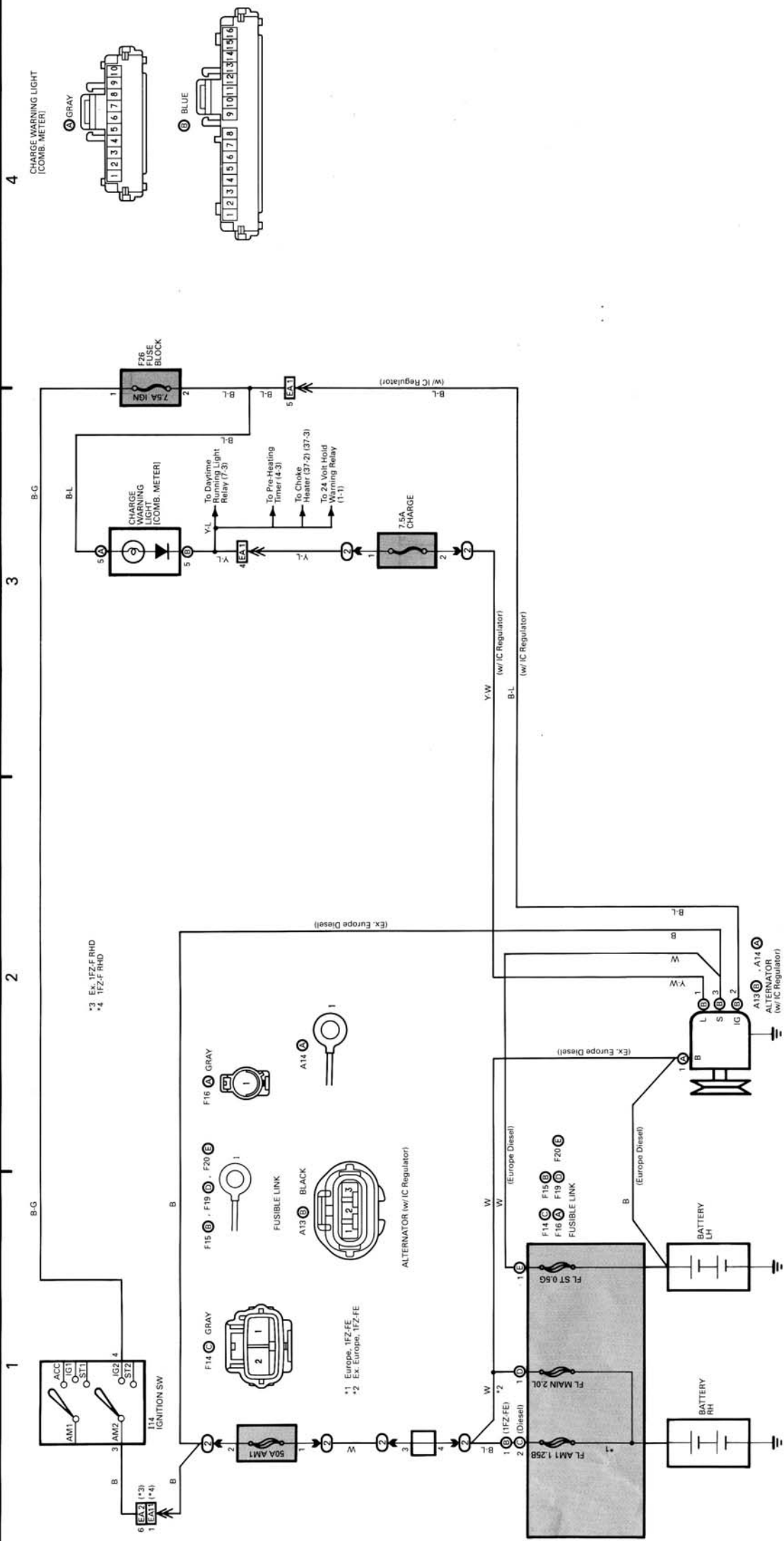

4

CHARGE WARNING LIGHT  
(COMB. METER)

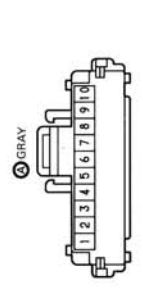

ⓐ GRAY

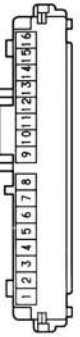

ⓑ BLUE



Headlight Cleaner



Satellite Navigation



Power Source

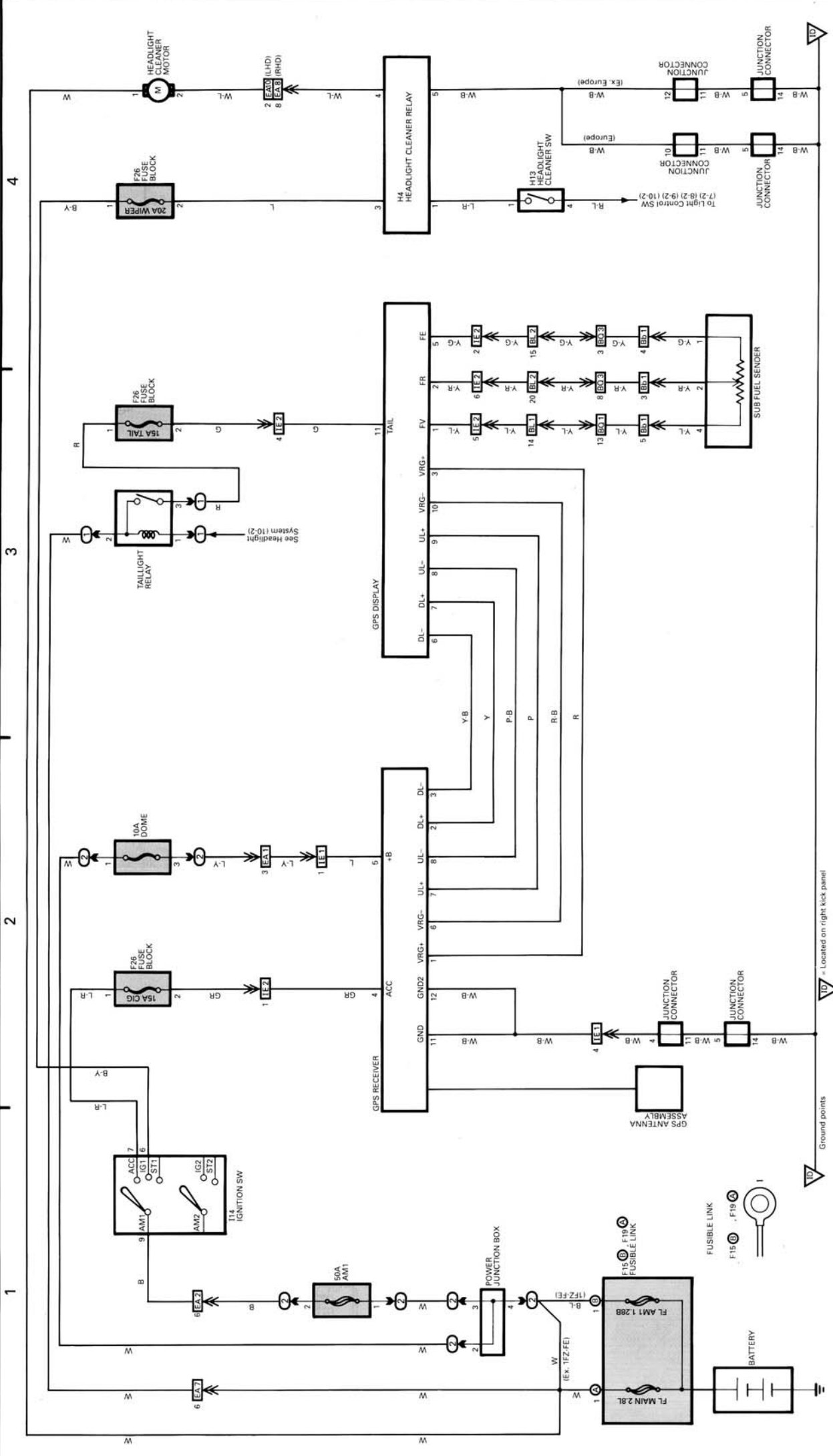

Ground points

107 - Located on right kick panel

# 4 LAND CRUISER (W/G)



Power Source



Glow Plug

4

3

2

1

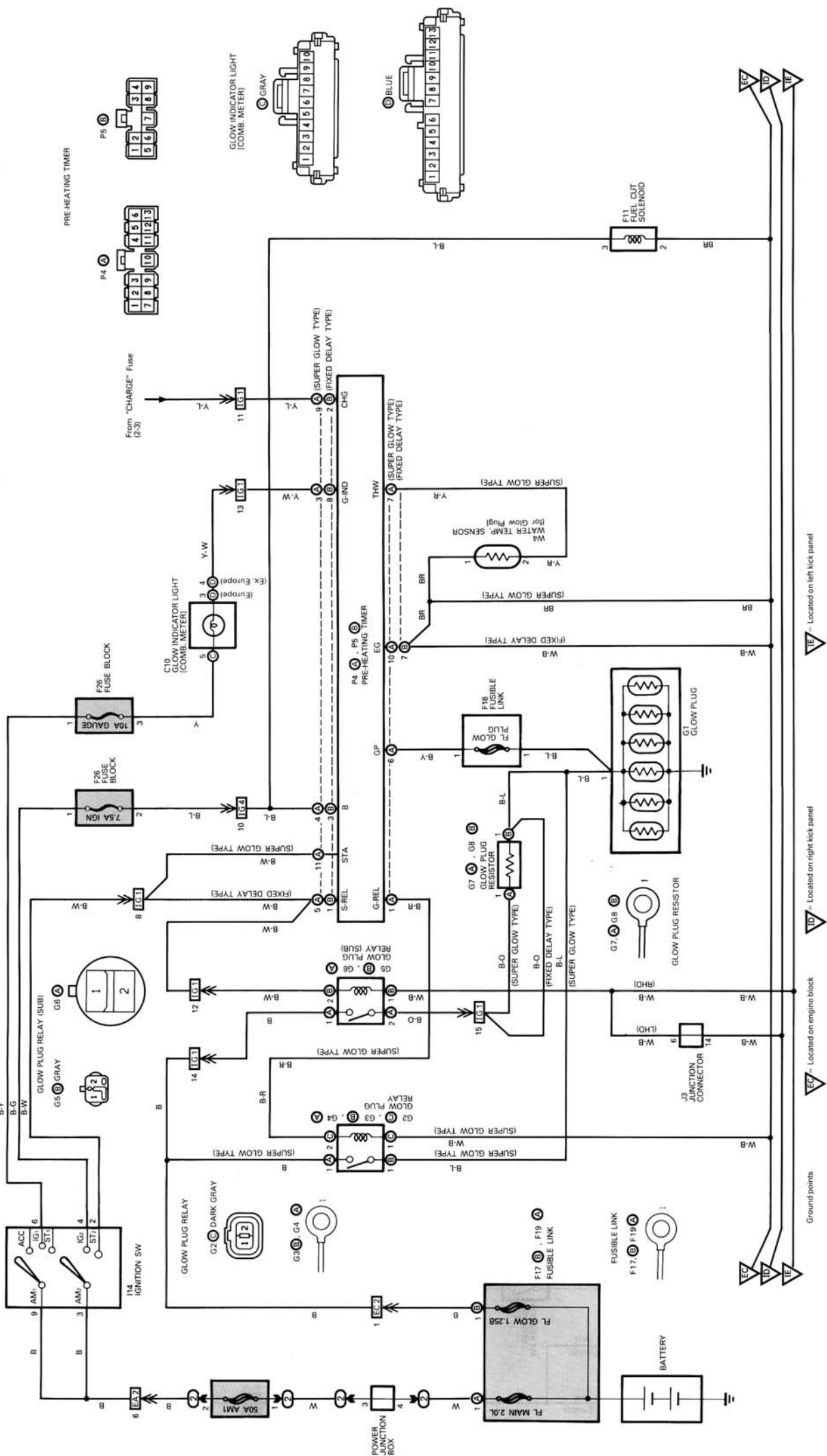

Ground points

EC - Located on engine block

TD - Located on right kick panel

IE - Located on left kick panel



Winch



PPS (Progressive Power Steering)



Power Source

4

3

2

1

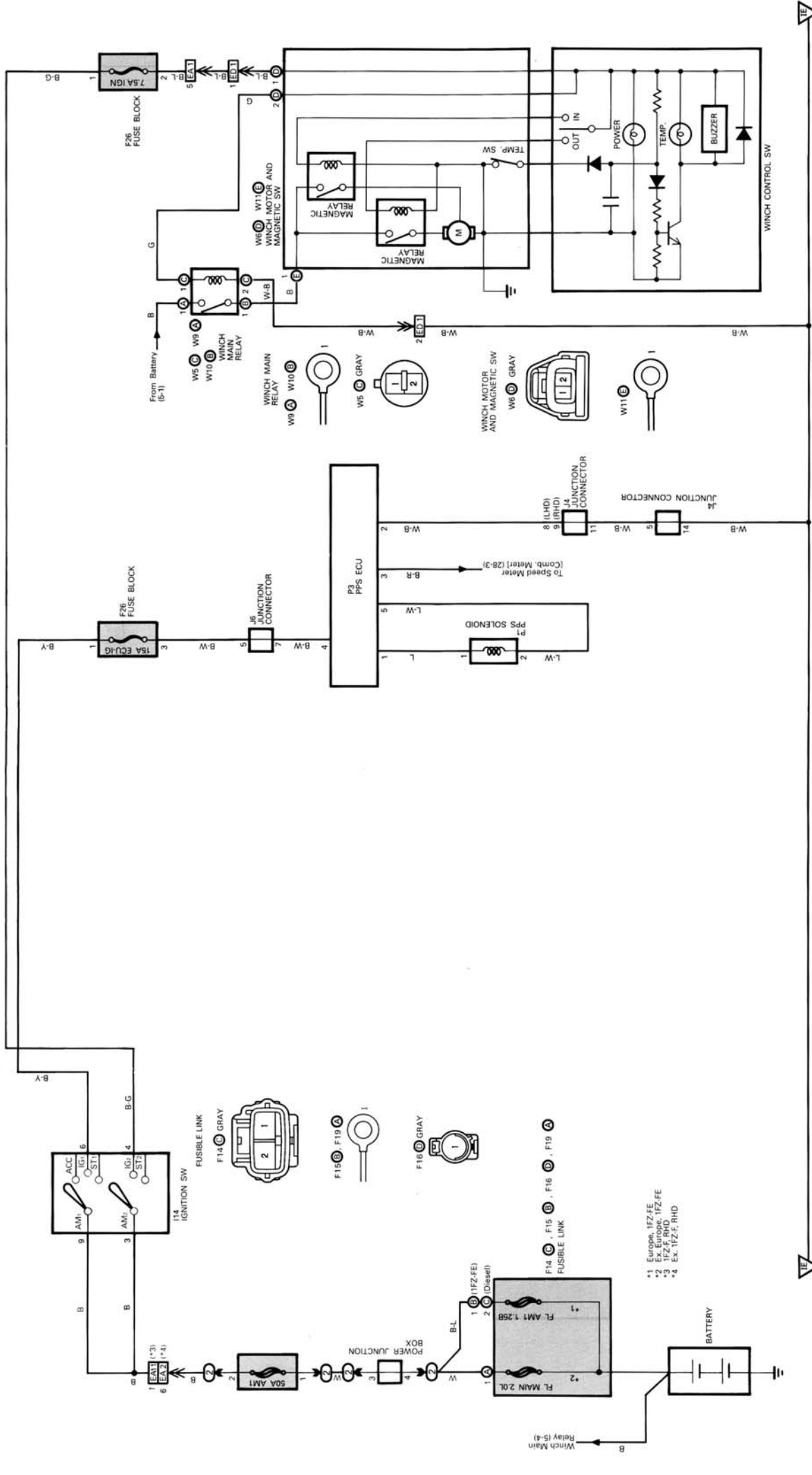

Ground points

TF = Located on left kick panel

- \*1 Europe, 1FZ-FE
- \*2 Europe, 1FZ-FE
- \*3 1FZ-F, RHD
- \*4 Ex-1FZ-F, RHD

# 6 LAND CRUISER (W/G)



Power Source



Headlight Beam Level Control

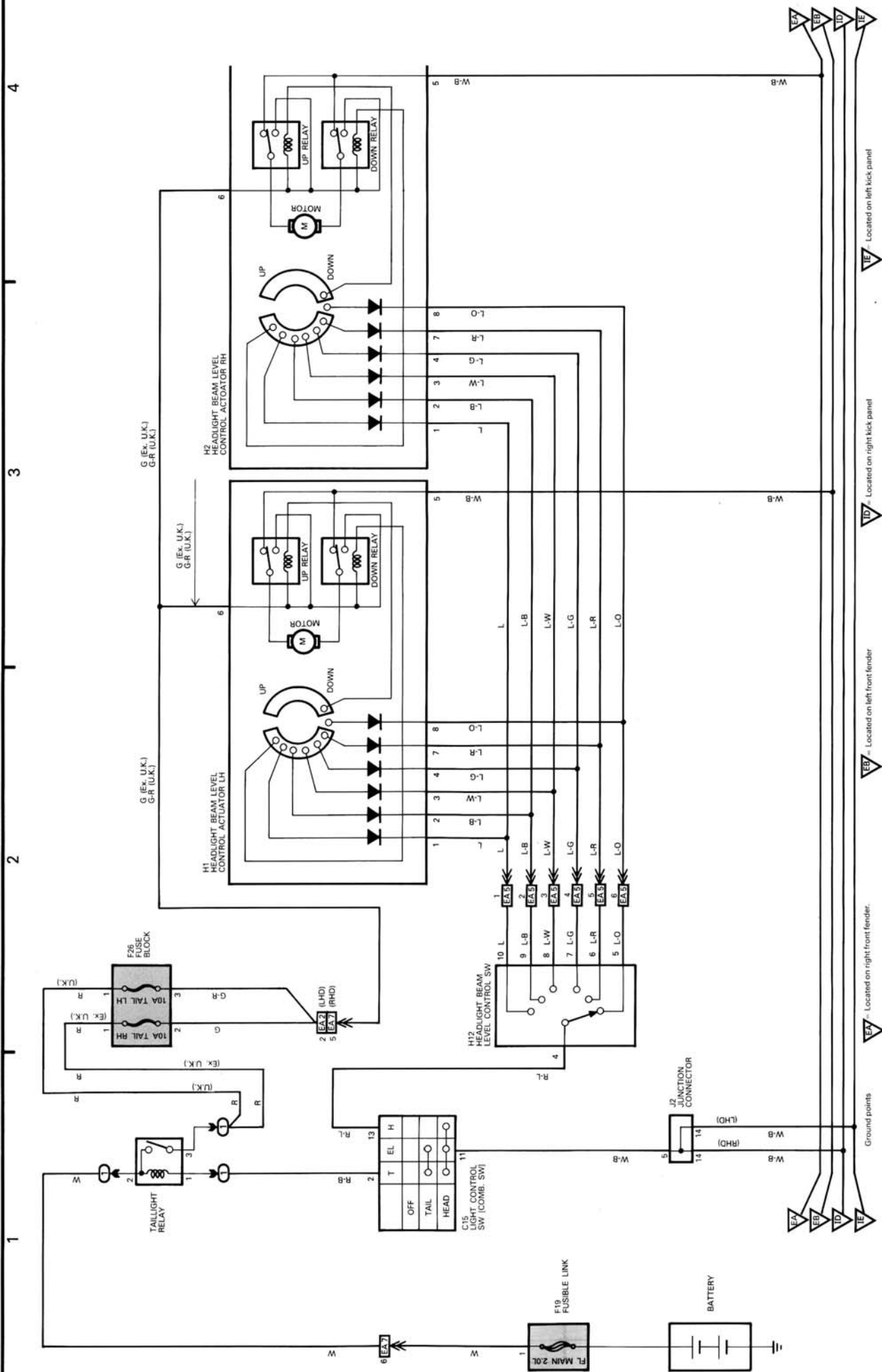

Headlight (w/ Daytime Running Light)



Power Source

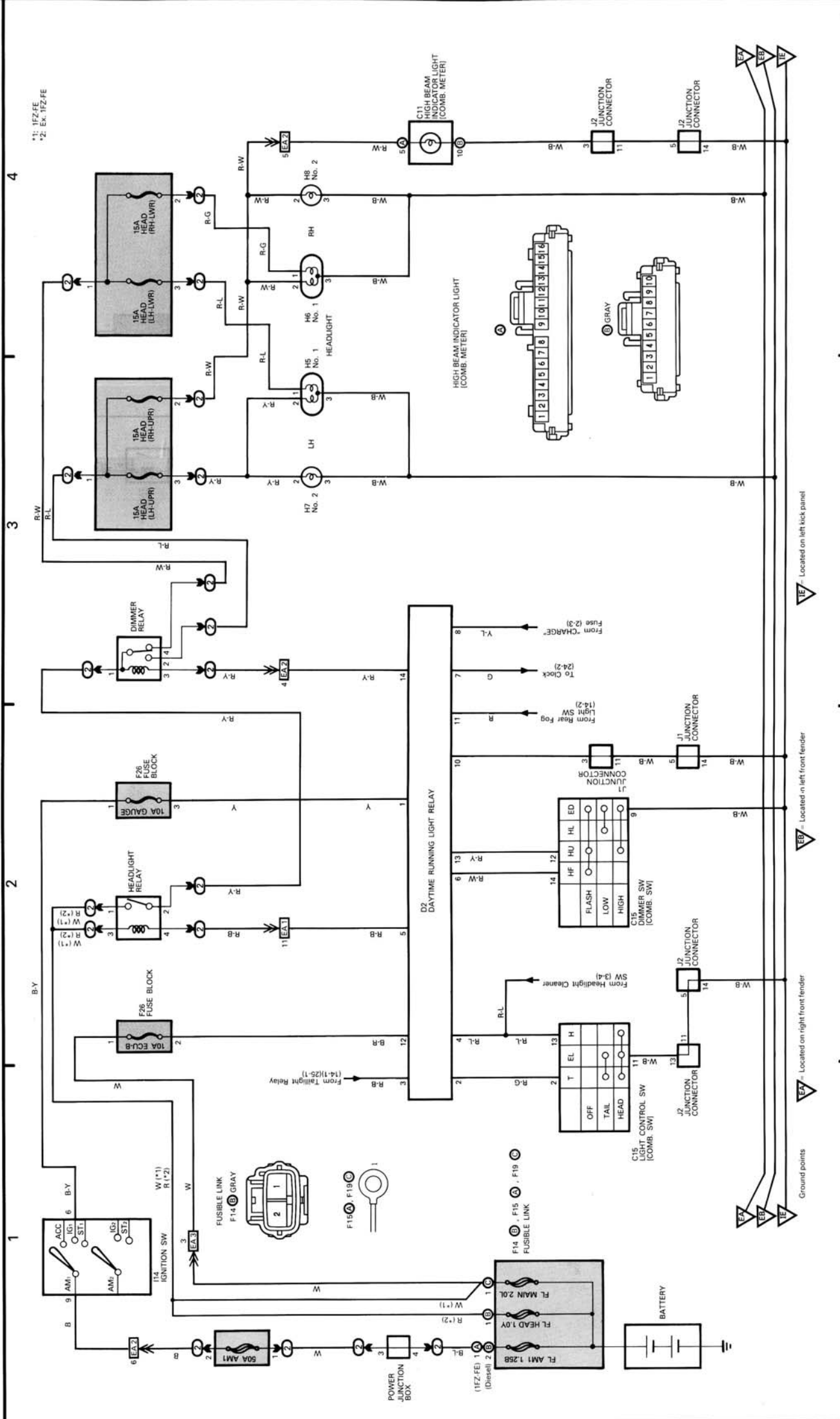

\*1: 1FZ-FE  
\*2: 5K-1FZFE

EA - Located on left fender

EB - Located on left front fender

EC - Located on right front fender

Ground points



# 8 LAND CRUISER (W/G)



Power Source



Headlight (LHD in Europe w/o Daytime Running Light)

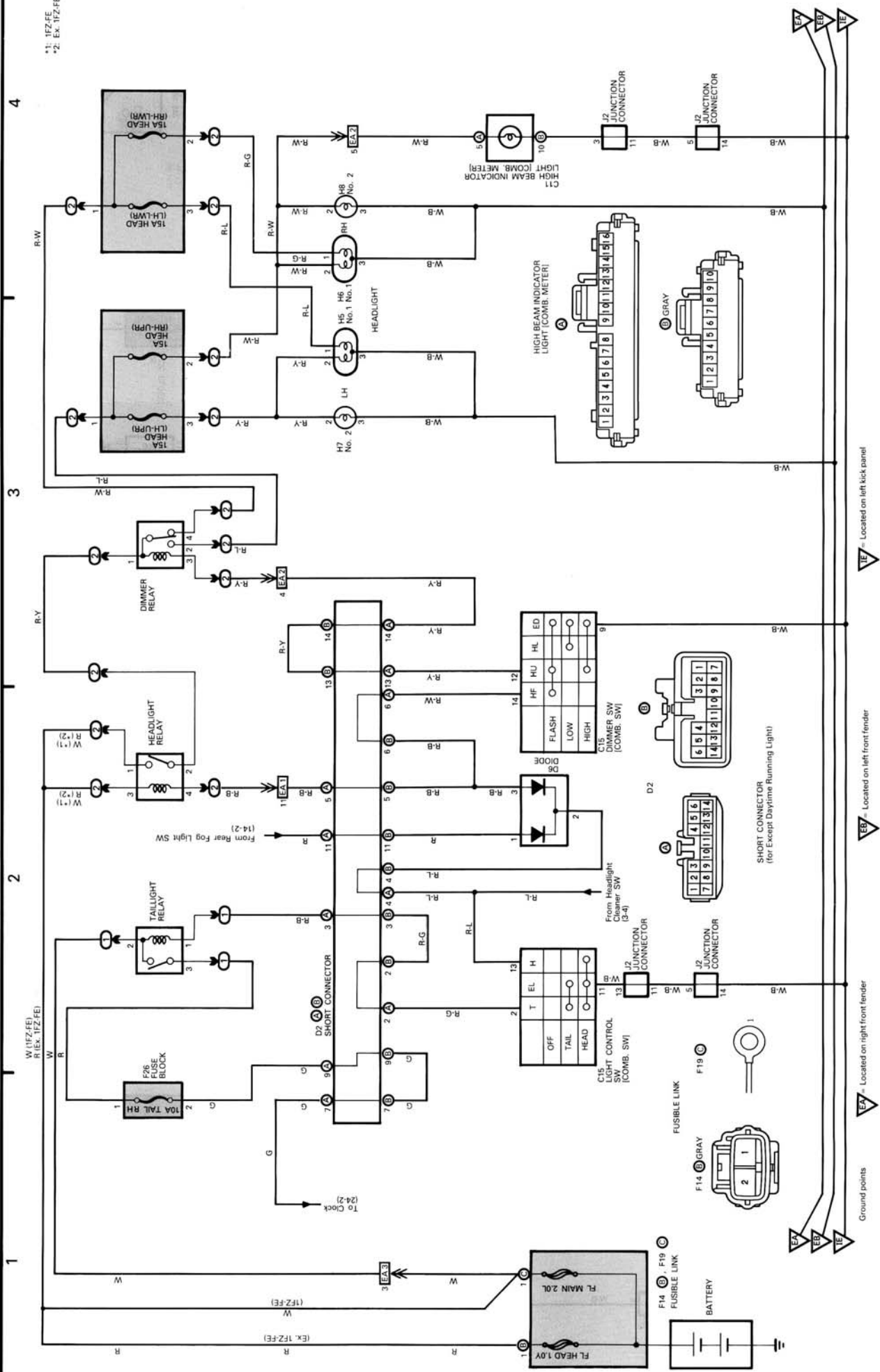



Power Source



Headlight (U.K.)

4

3

2

1

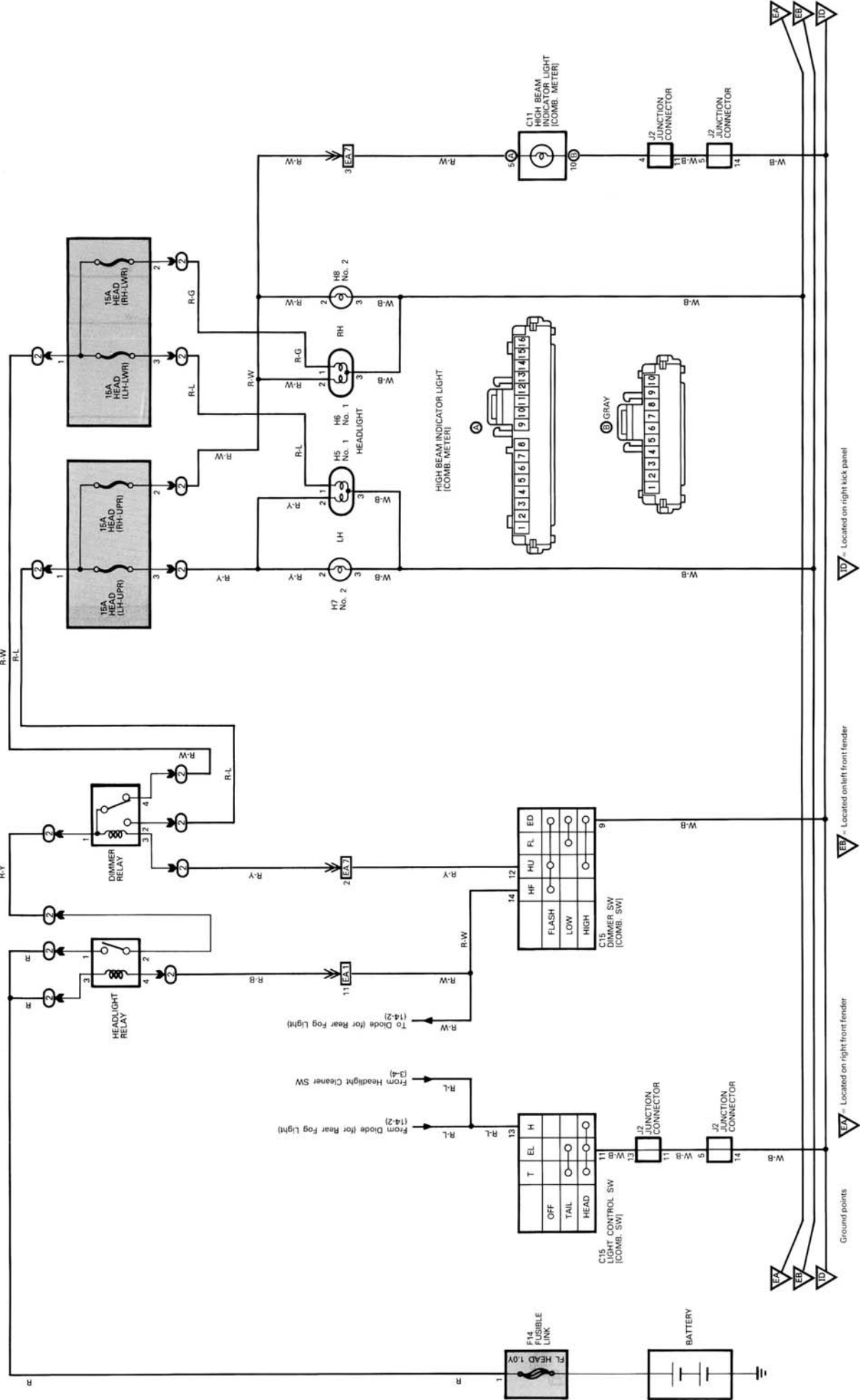

Ground points

EA' = Located on right front fender

EB = Located on left front fender

EA = Located on right kick panel

# 10 LAND CRUISER (W/G)



Power Source



Headlight (Ex. LHD in Europe)

4

3

2

1

- \*1: 1FZ-FE LHD, 1FZ-FE 1HZ LHD, 1HD-T LHD
- \*2: 1FZ-FE LHD, 1FZ-FE 1HZ LHD, 1HD-T LHD
- \*3: 1HZ-RHD, 1HD-T-RHD
- \*4: 1FZ-FE RHD, 1FZ-F RHD

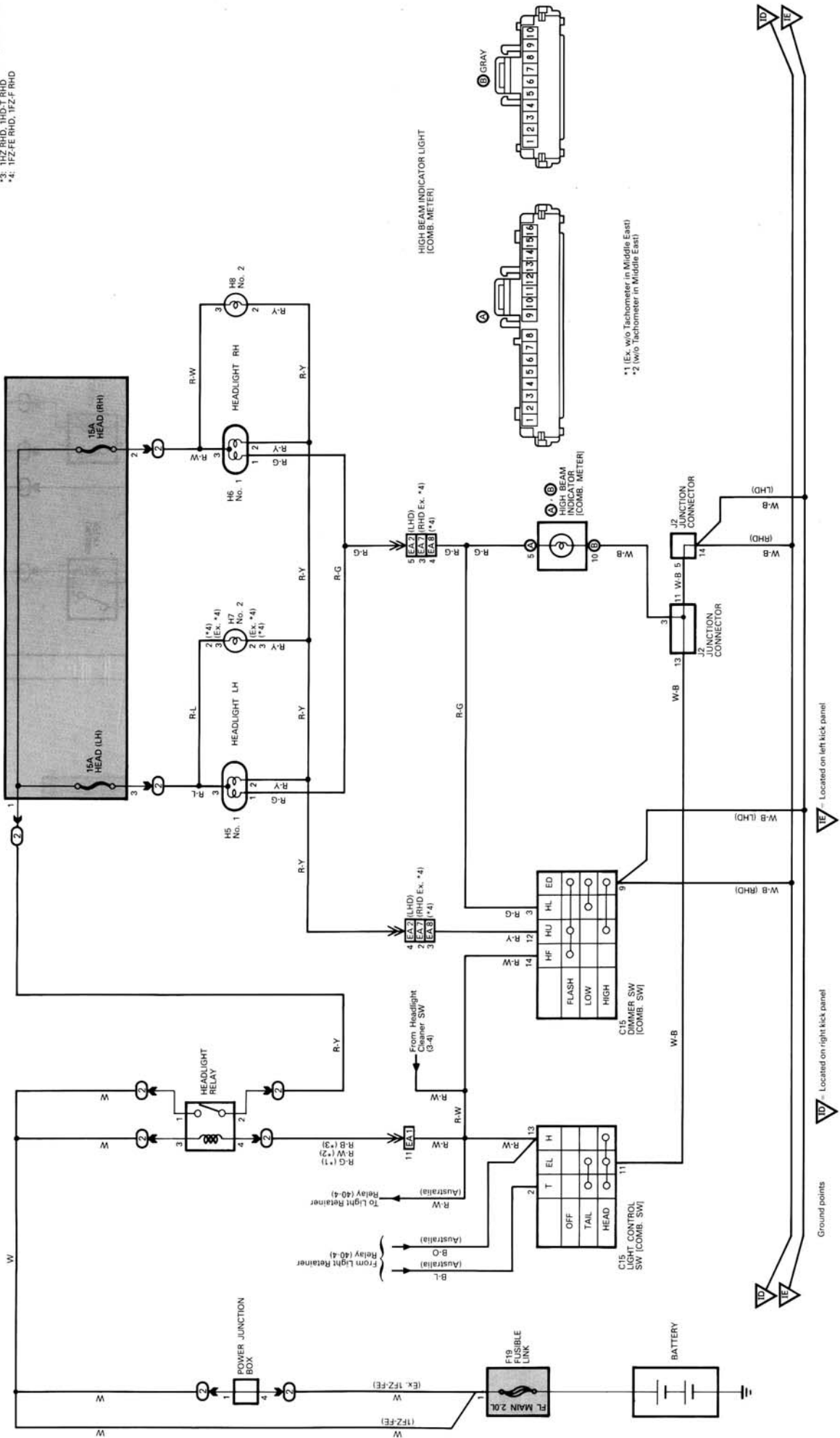

HIGH BEAM INDICATOR LIGHT (COMB. METER)

\*1 (Ex. w/o Tachometer in Middle East)  
\*2 (w/o Tachometer in Middle East)

Ground points  
ID - Located on right kick panel  
IE - Located on left kick panel



Power Source



Interior Light

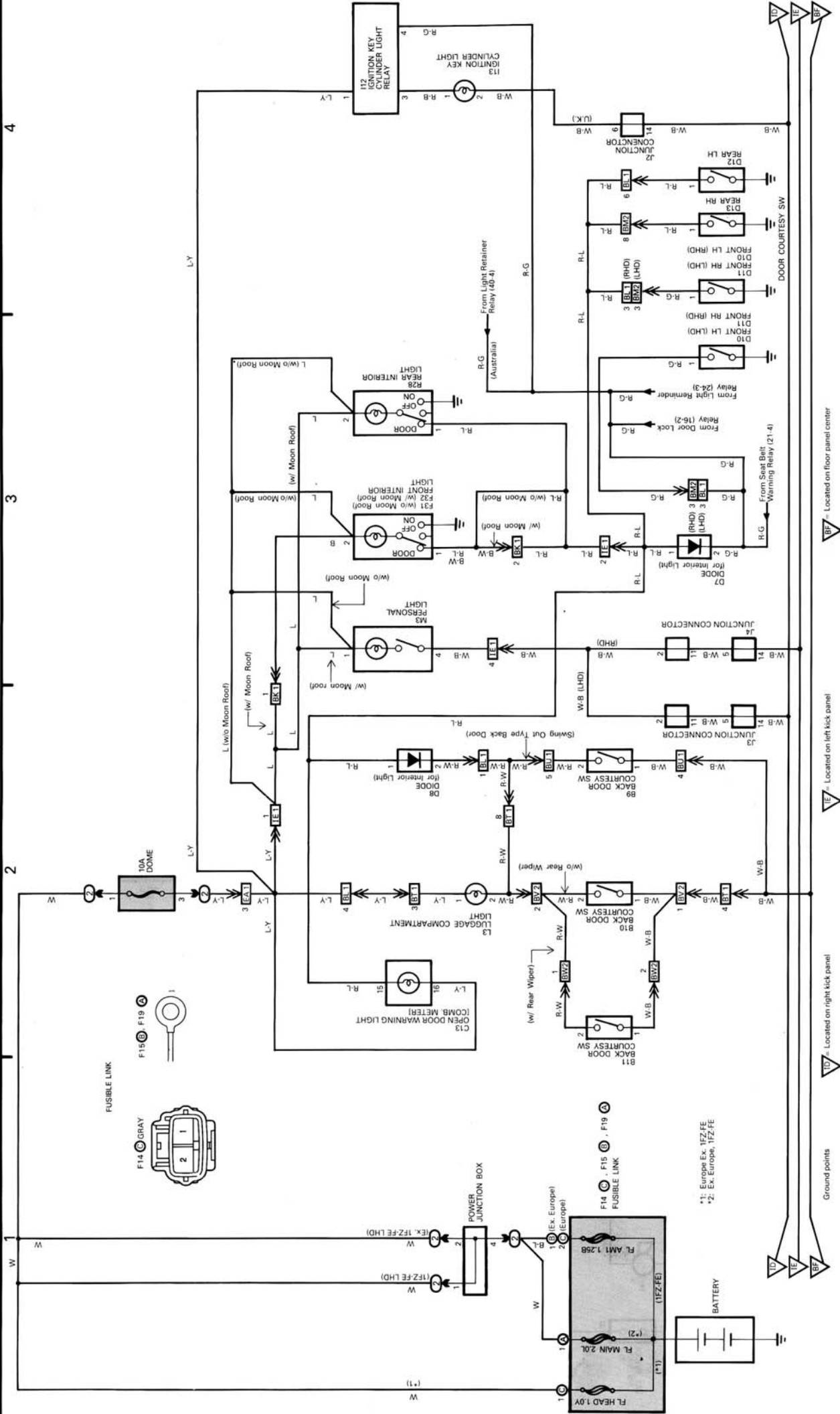

\*1: Europe Ex. 1FZ FE  
\*2: Ex. Europe, 1FZ FE

Ground points  
TD - Located on right kick panel  
IE - Located on left kick panel  
BF - Located on floor panel center

# 12 LAND CRUISER (W/G)

## Power Source

## Turn Signal and Hazard Warning Light

## Horn

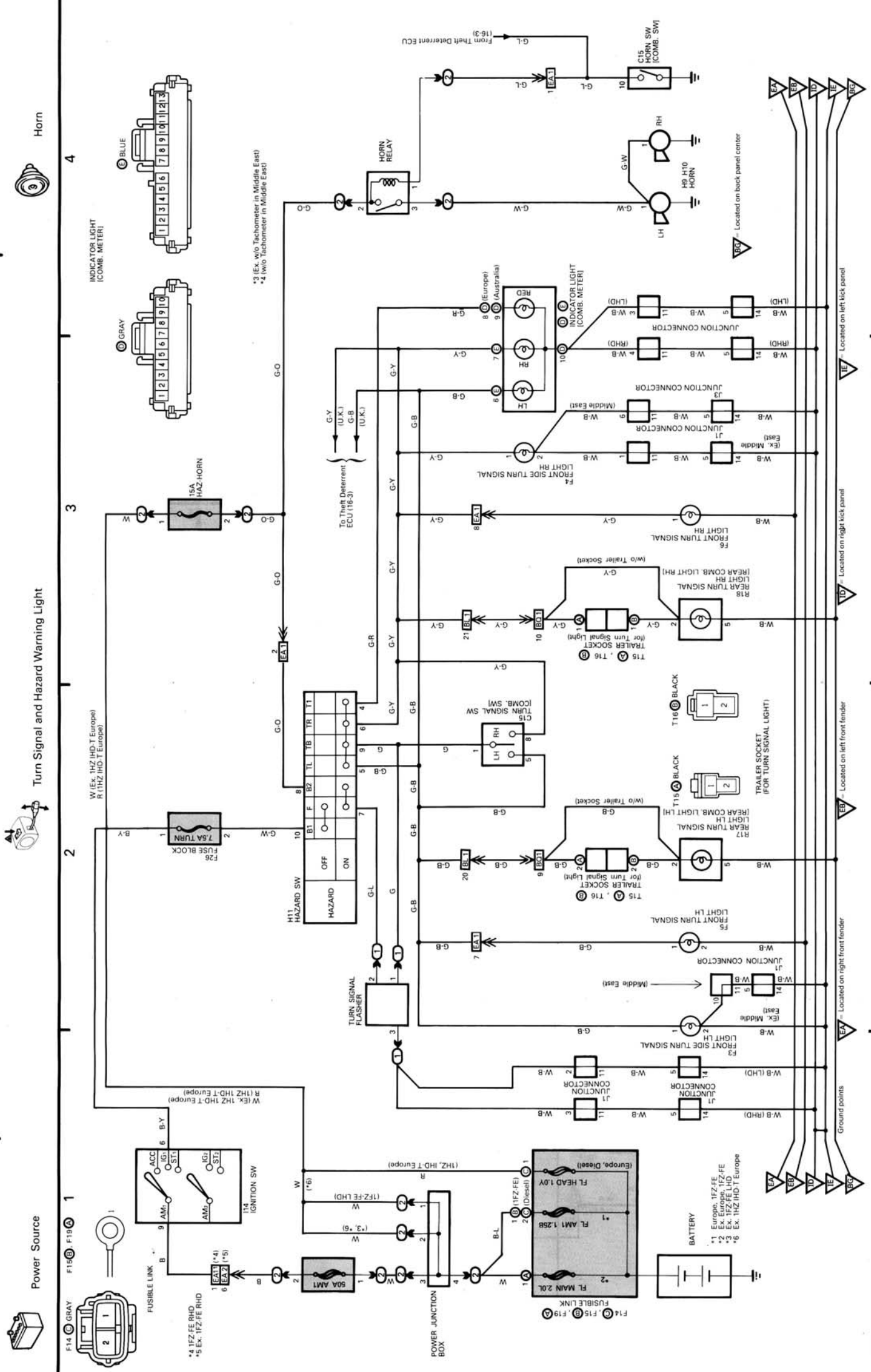

\*3 (Ex. w/o Tachometer in Middle East)

\*4 (w/o Tachometer in Middle East)

\*5 (Ex. 1F2FE RHD)

\*6 (Ex. 1F2FE LHD)

\*7 (Ex. 1H2 T Europe)

\*8 (Ex. 1H2 T Europe)

\*9 (Ex. 1H2 T Europe)

\*10 (Ex. 1H2 T Europe)

\*11 (Ex. 1H2 T Europe)

\*12 (Ex. 1H2 T Europe)

\*13 (Ex. 1H2 T Europe)

\*14 (Ex. 1H2 T Europe)

\*15 (Ex. 1H2 T Europe)

\*16 (Ex. 1H2 T Europe)

\*17 (Ex. 1H2 T Europe)

\*18 (Ex. 1H2 T Europe)

\*19 (Ex. 1H2 T Europe)

\*20 (Ex. 1H2 T Europe)

\*21 (Ex. 1H2 T Europe)

\*22 (Ex. 1H2 T Europe)

\*23 (Ex. 1H2 T Europe)

\*24 (Ex. 1H2 T Europe)

\*25 (Ex. 1H2 T Europe)

\*26 (Ex. 1H2 T Europe)

\*27 (Ex. 1H2 T Europe)

\*28 (Ex. 1H2 T Europe)

\*29 (Ex. 1H2 T Europe)

\*30 (Ex. 1H2 T Europe)

\*31 (Ex. 1H2 T Europe)

\*32 (Ex. 1H2 T Europe)

\*33 (Ex. 1H2 T Europe)

\*34 (Ex. 1H2 T Europe)

\*35 (Ex. 1H2 T Europe)

\*36 (Ex. 1H2 T Europe)

\*37 (Ex. 1H2 T Europe)

\*38 (Ex. 1H2 T Europe)

\*39 (Ex. 1H2 T Europe)

\*40 (Ex. 1H2 T Europe)

\*41 (Ex. 1H2 T Europe)

\*42 (Ex. 1H2 T Europe)

\*43 (Ex. 1H2 T Europe)

\*44 (Ex. 1H2 T Europe)

\*45 (Ex. 1H2 T Europe)

\*46 (Ex. 1H2 T Europe)

\*47 (Ex. 1H2 T Europe)

\*48 (Ex. 1H2 T Europe)

\*49 (Ex. 1H2 T Europe)

\*50 (Ex. 1H2 T Europe)

\*51 (Ex. 1H2 T Europe)

\*52 (Ex. 1H2 T Europe)

\*53 (Ex. 1H2 T Europe)

\*54 (Ex. 1H2 T Europe)

\*55 (Ex. 1H2 T Europe)

\*56 (Ex. 1H2 T Europe)

\*57 (Ex. 1H2 T Europe)

\*58 (Ex. 1H2 T Europe)

\*59 (Ex. 1H2 T Europe)

\*60 (Ex. 1H2 T Europe)

\*61 (Ex. 1H2 T Europe)

\*62 (Ex. 1H2 T Europe)

\*63 (Ex. 1H2 T Europe)

\*64 (Ex. 1H2 T Europe)

\*65 (Ex. 1H2 T Europe)

\*66 (Ex. 1H2 T Europe)

\*67 (Ex. 1H2 T Europe)

\*68 (Ex. 1H2 T Europe)

\*69 (Ex. 1H2 T Europe)

\*70 (Ex. 1H2 T Europe)

\*71 (Ex. 1H2 T Europe)

\*72 (Ex. 1H2 T Europe)

\*73 (Ex. 1H2 T Europe)

\*74 (Ex. 1H2 T Europe)

\*75 (Ex. 1H2 T Europe)

\*76 (Ex. 1H2 T Europe)

\*77 (Ex. 1H2 T Europe)

\*78 (Ex. 1H2 T Europe)

\*79 (Ex. 1H2 T Europe)

\*80 (Ex. 1H2 T Europe)

\*81 (Ex. 1H2 T Europe)

\*82 (Ex. 1H2 T Europe)

\*83 (Ex. 1H2 T Europe)

\*84 (Ex. 1H2 T Europe)

\*85 (Ex. 1H2 T Europe)

\*86 (Ex. 1H2 T Europe)

\*87 (Ex. 1H2 T Europe)

\*88 (Ex. 1H2 T Europe)

\*89 (Ex. 1H2 T Europe)

\*90 (Ex. 1H2 T Europe)

\*91 (Ex. 1H2 T Europe)

\*92 (Ex. 1H2 T Europe)

\*93 (Ex. 1H2 T Europe)

\*94 (Ex. 1H2 T Europe)

\*95 (Ex. 1H2 T Europe)

\*96 (Ex. 1H2 T Europe)

\*97 (Ex. 1H2 T Europe)

\*98 (Ex. 1H2 T Europe)

\*99 (Ex. 1H2 T Europe)

\*100 (Ex. 1H2 T Europe)

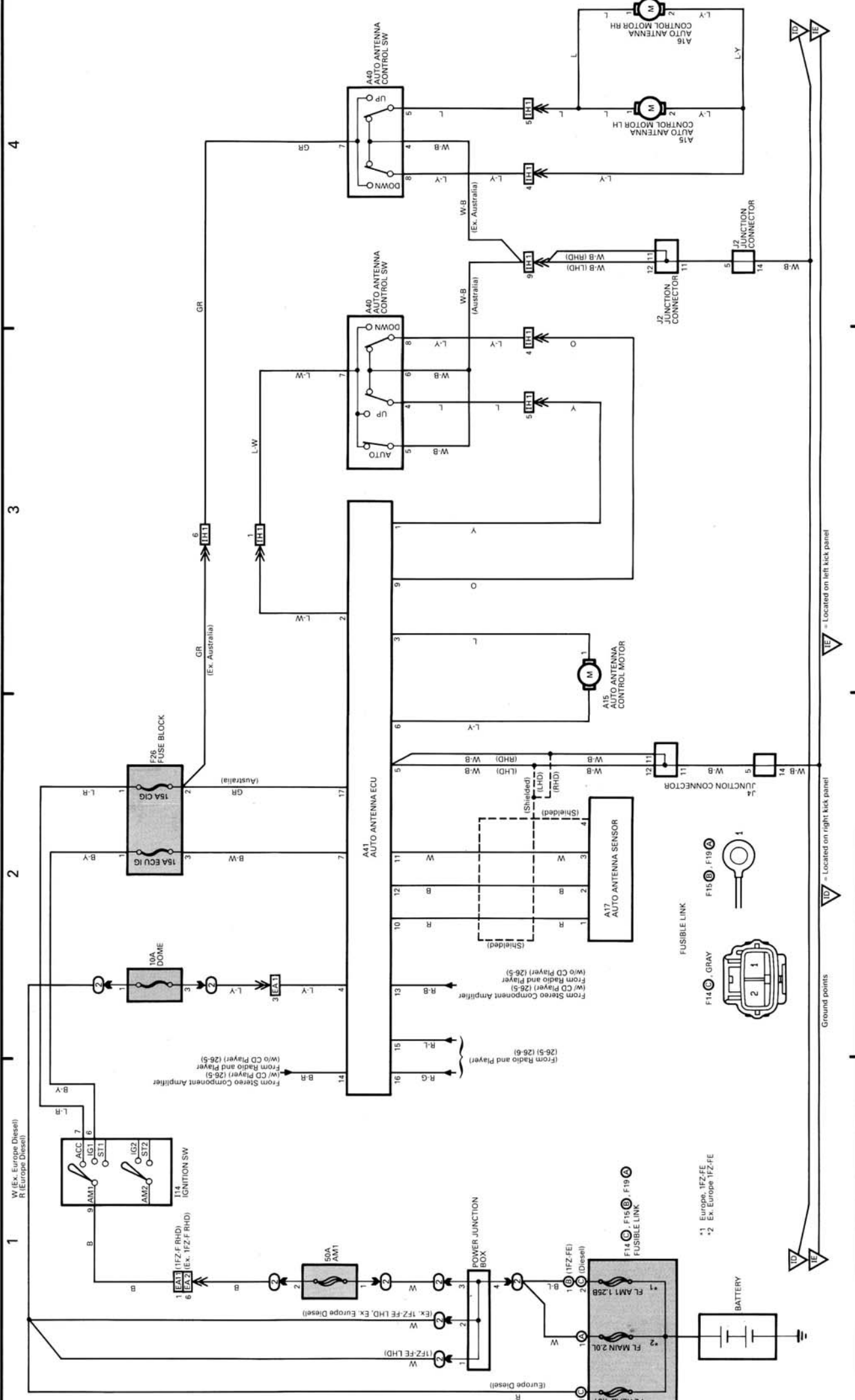

\*1 Europe, 1FZ-FE  
\*2 Ex. Europe 1FZ-FE

Ground points  
 = Located on right kick panel  
 = Located on left kick panel

# 14 LAND CRUISER (W/G)



Power Source



Rear Fog Light

4

3

2

1

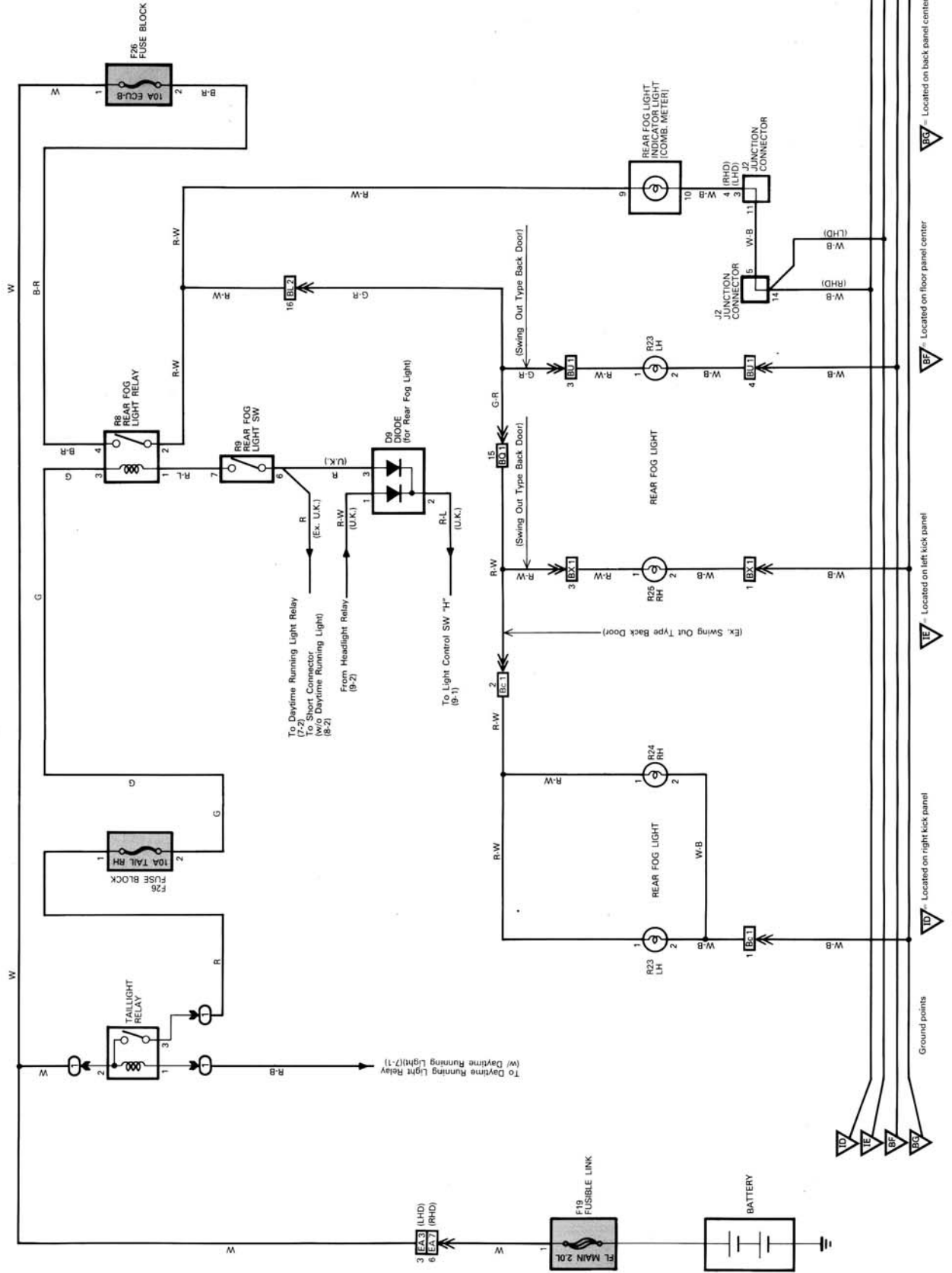



Power Source



Power Window

4

3

2

1

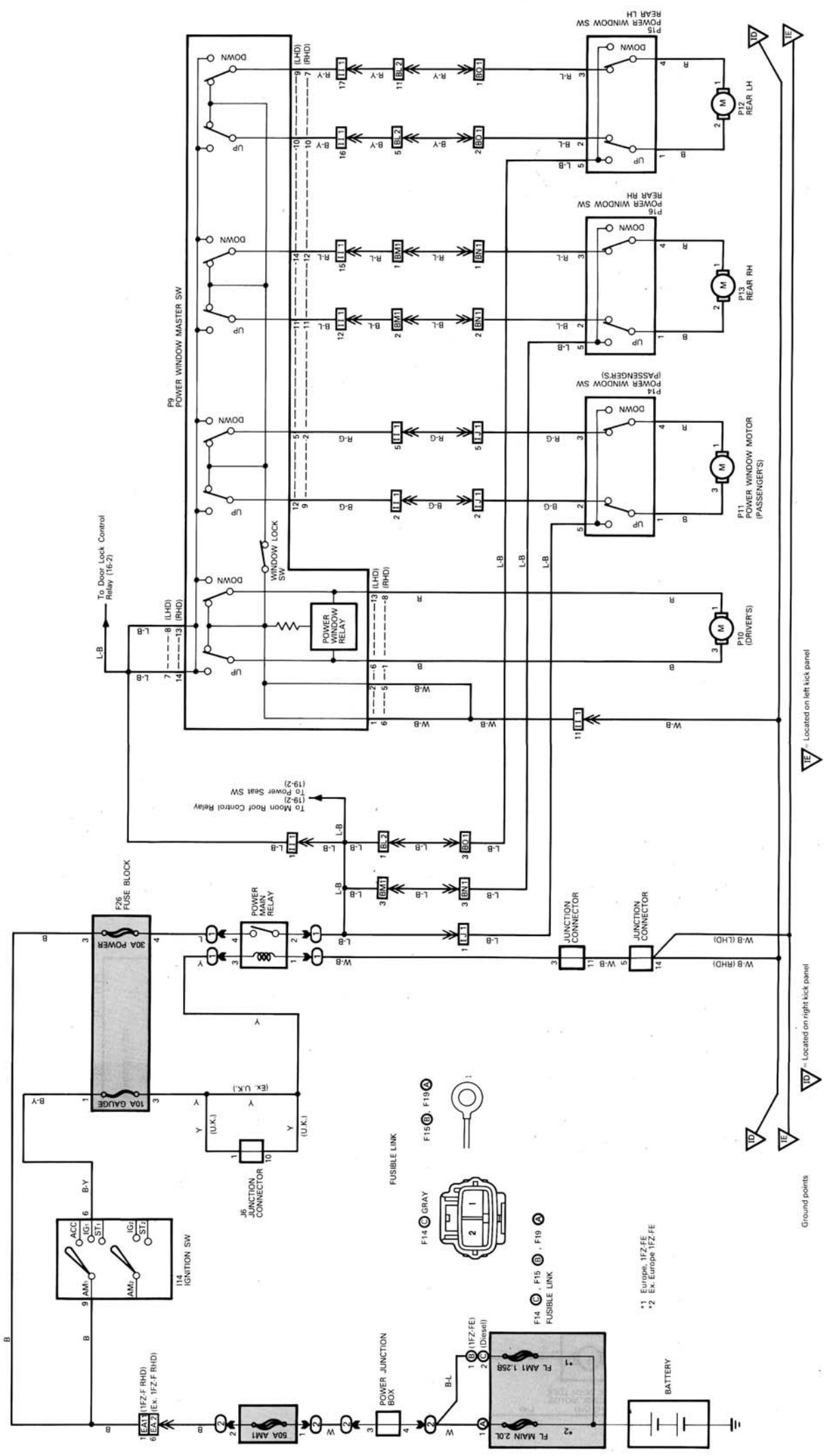

\*1 Europe, 1EZF, FE  
 \*2 Ex. Europe 1EZF, FE

Ground points

ID' - Located on right kick panel

ID - Located on left kick panel



# 16 LAND CRUISER (W/G)



Power Source



Theft Deterrent and Door Lock

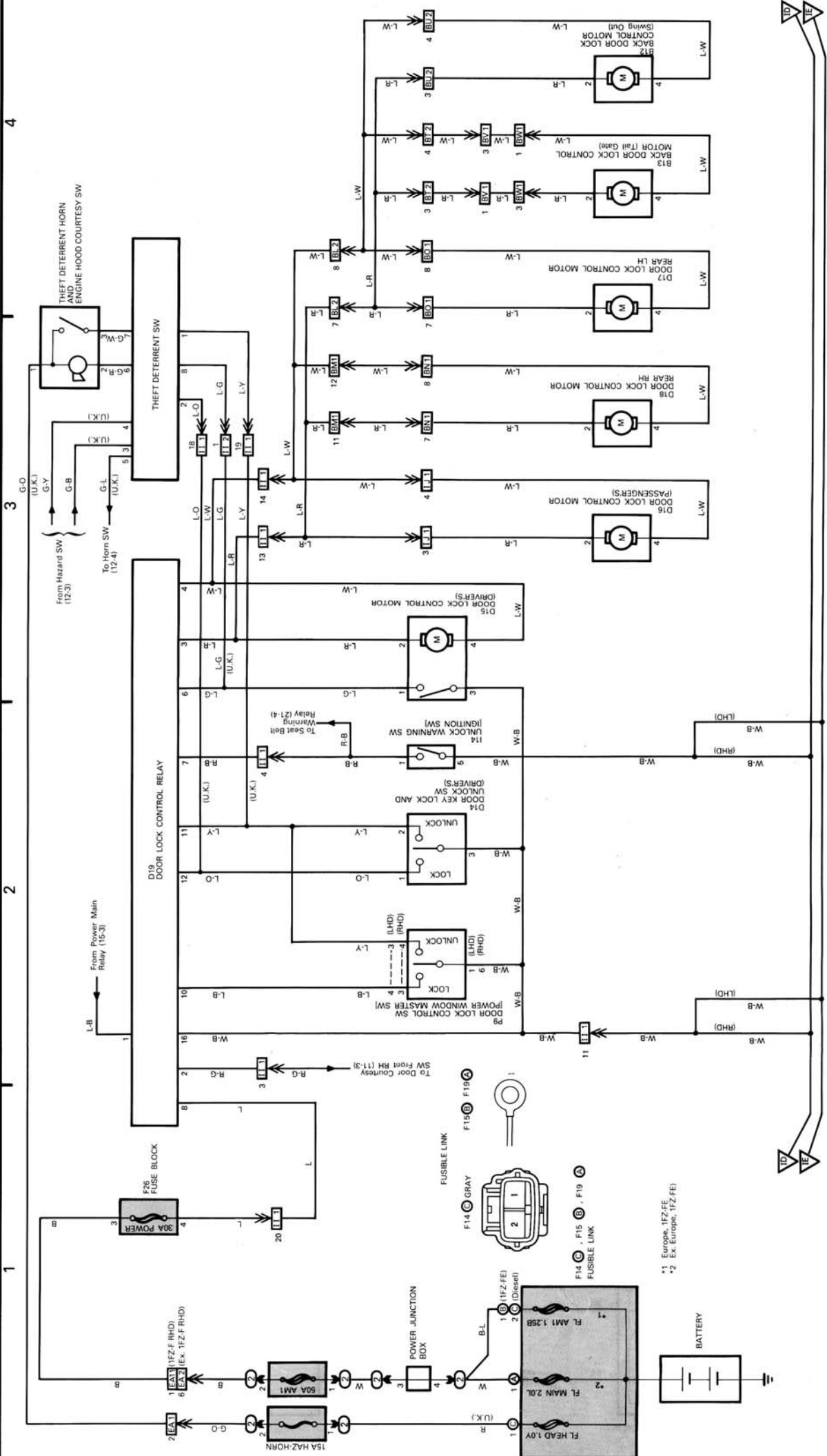

Ground points  
 ID7 - Located on right kick panel  
 IE7 - Located on left kick panel

\*1 Europe, 1FZ-FE  
 \*2 Ex. Europe, 1FZ-FE

Front Wiper and Washer (1HZ, IHD-T)

Rear Wiper and Washer (1HZ, IHD-T)

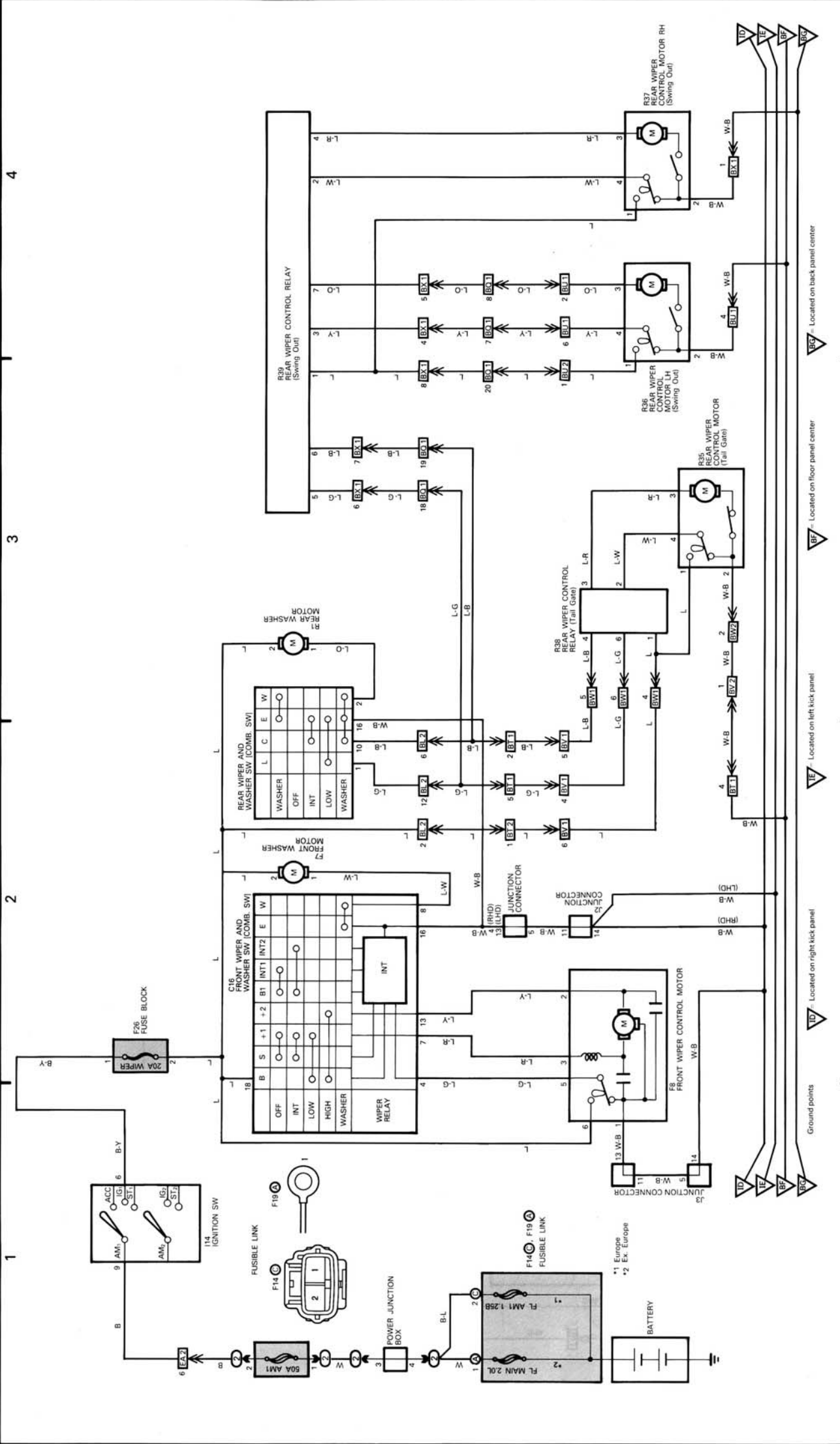

# 18 LAND CRUISER (W/G)

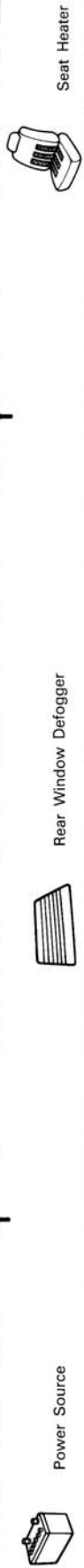

4

3

2

1

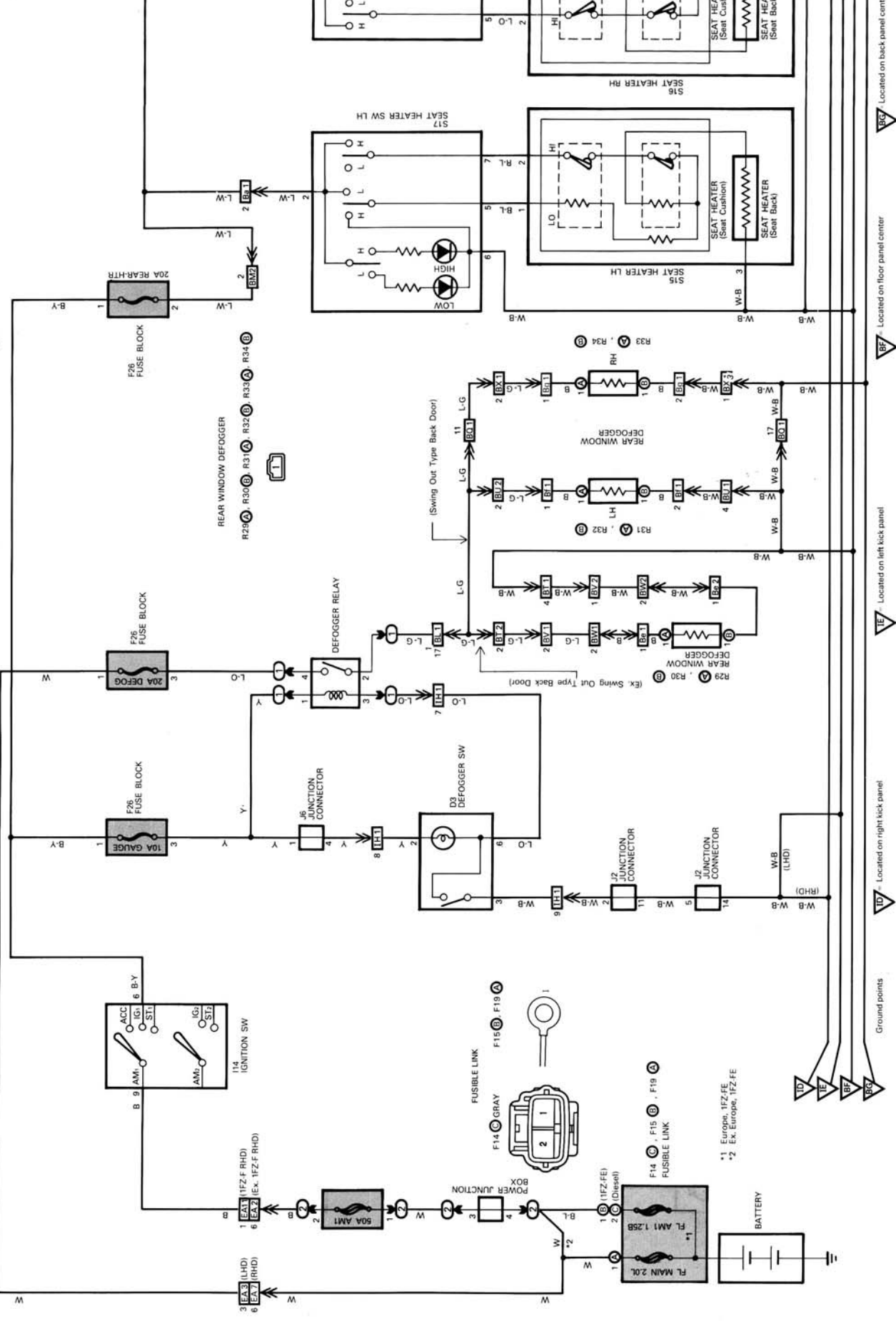

Ground points

UD - Located on right kick panel

VE - Located on left kick panel

BF - Located on floor panel center

BG - Located on back panel center

\*1 Europe, 1FZ-FE  
\*2 Ex. Europe, 1FZ-FE

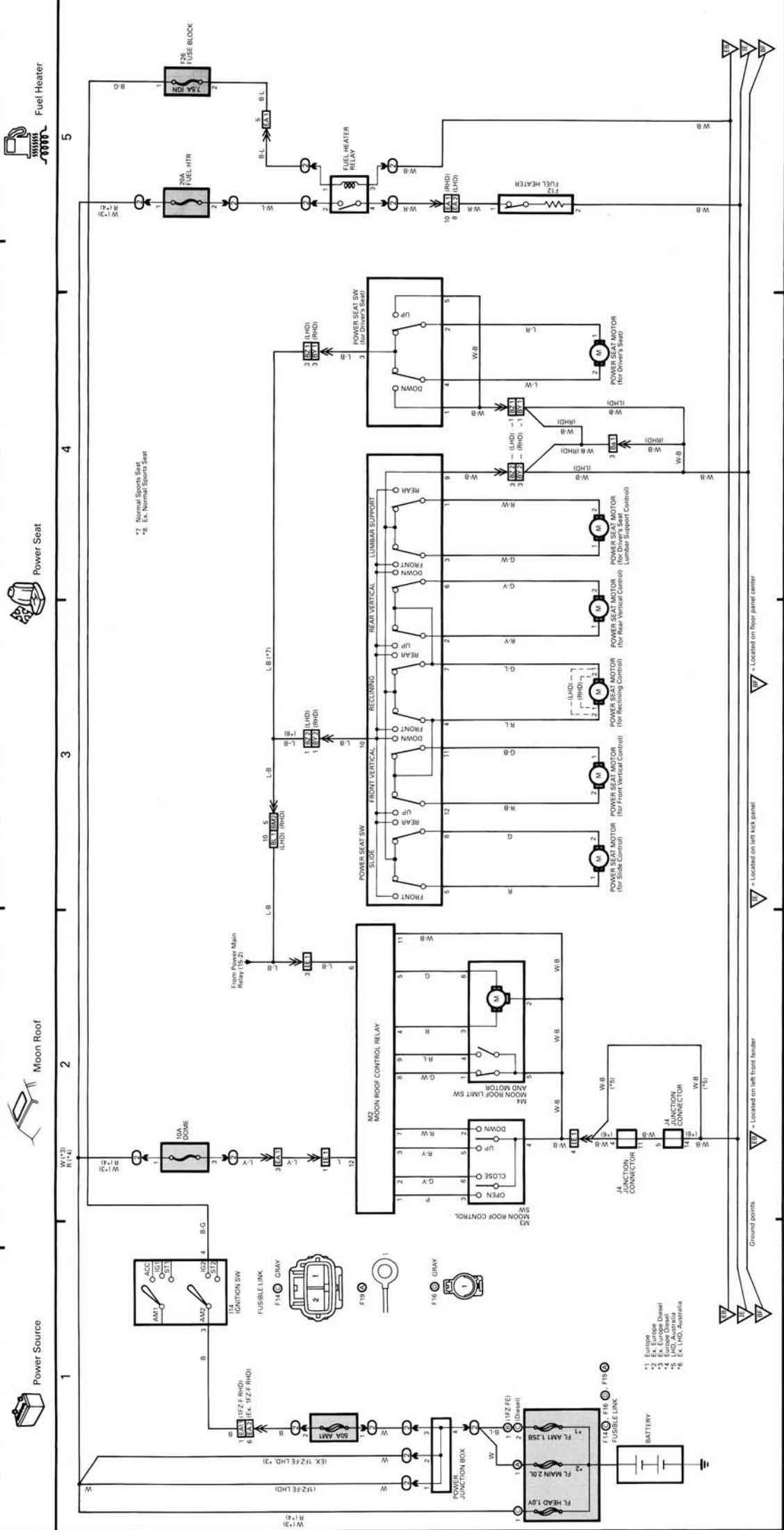

\*7 Normal Sports Seat  
 \*8 Ex. Normal Sports Seat

- \*1 Europe
- \*2 Ex. Europe
- \*3 Ex. Europe Diesel
- \*4 LHD, Australia
- \*5 LHD, Australia
- \*6 Ex. LHD, Australia

▲ = Located on left kick panel

▲ = Located on floor panel center

▲ = Located on left front tender

▲ = Ground points

# 20 LAND CRUISER (W/G)

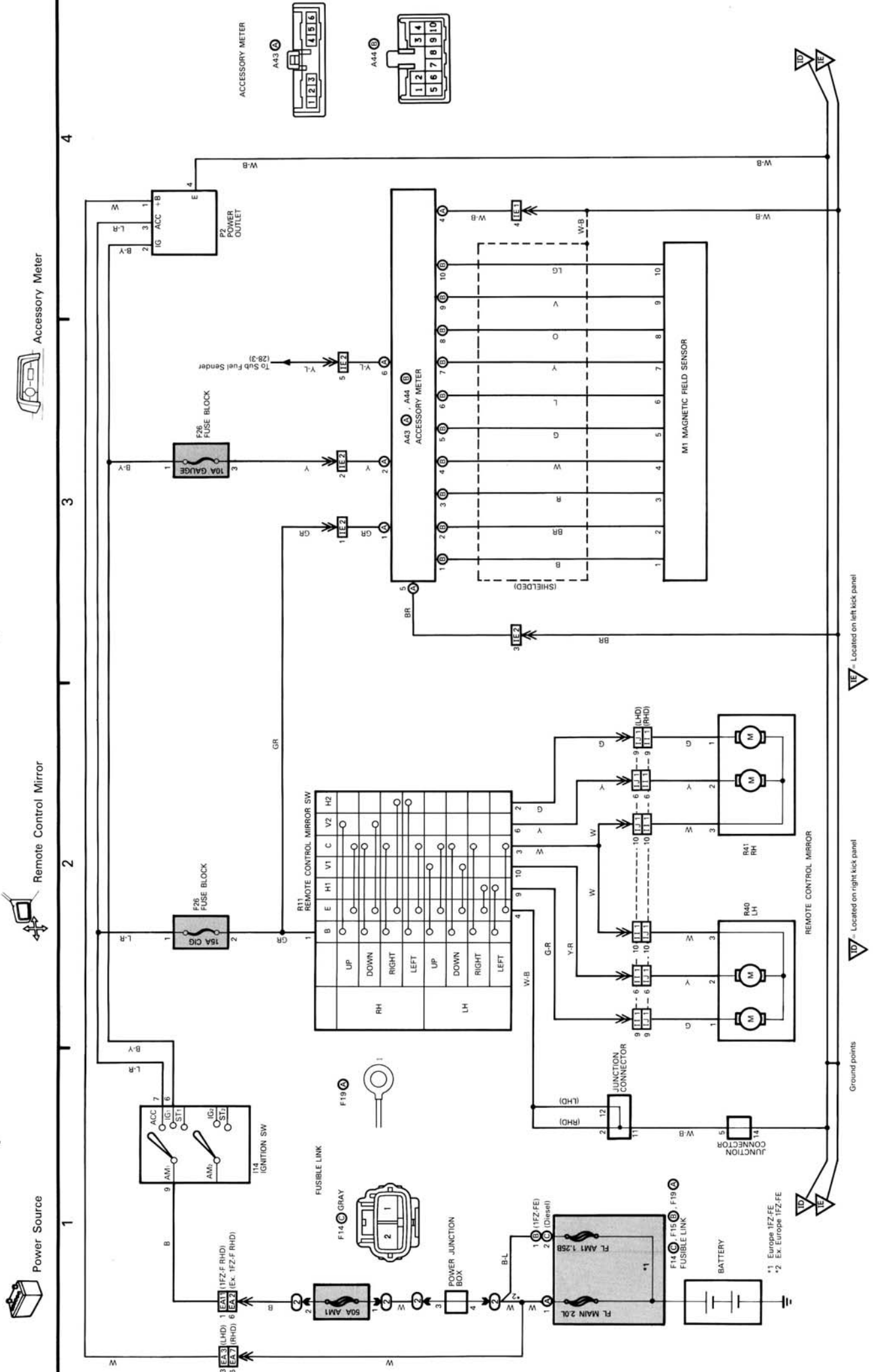

\*1 Europe 1FZ-FE  
\*2 Ex. Europe 1FZ-FE

Ground points

IE7 - Located on right kick panel

IE - Located on left kick panel

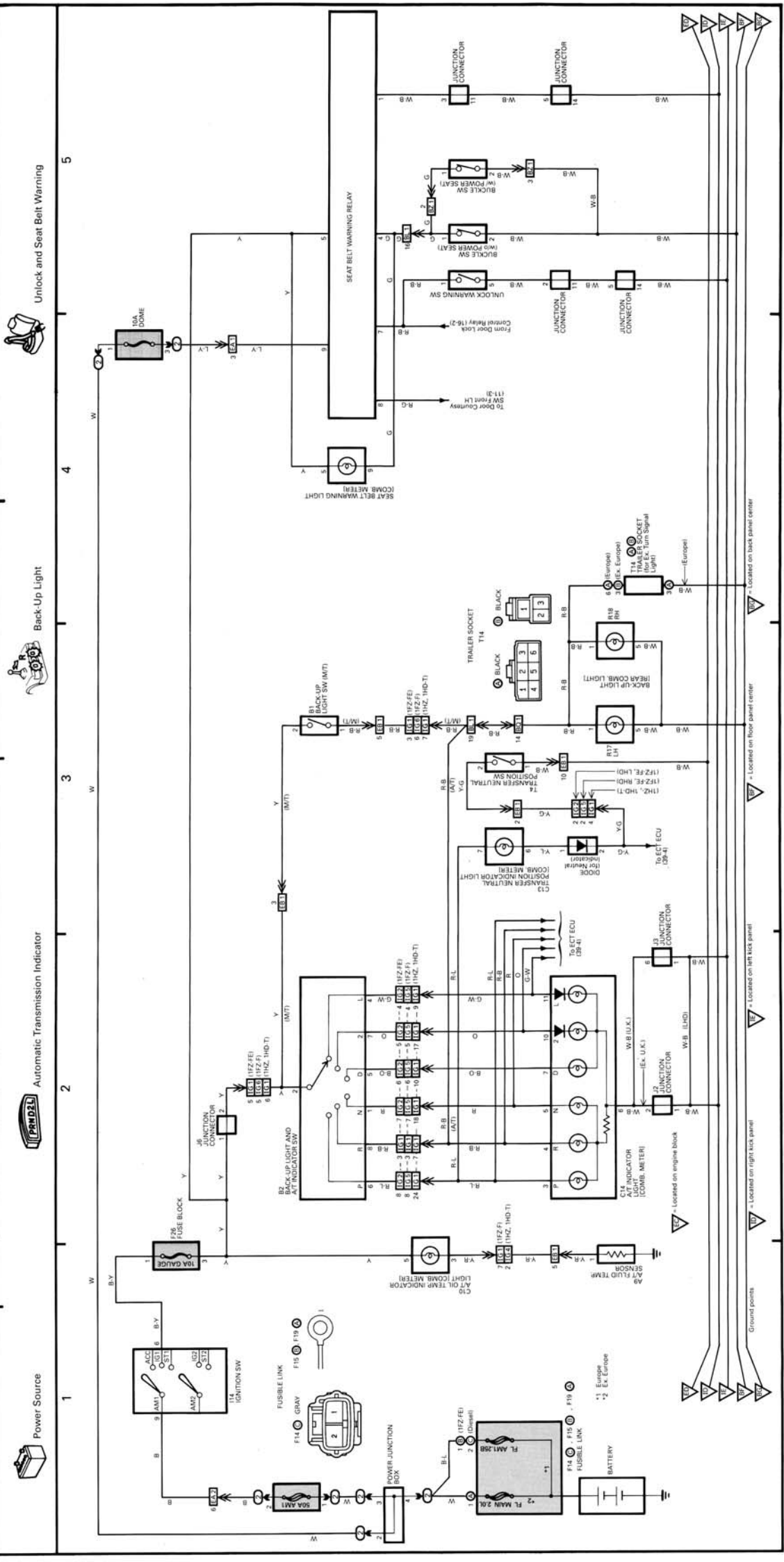

Unlock and Seat Belt Warning



Back-Up Light



Automatic Transmission Indicator



Power Source

1 2 3 4 5

W-B = Located on back panel center  
W-B = Located on floor panel center  
W-B = Located on left kick panel  
W-B = Located on right kick panel  
Ground points

\*1 Europe  
\*2 Ex. Europe

22 LAND CRUISER (W/G)

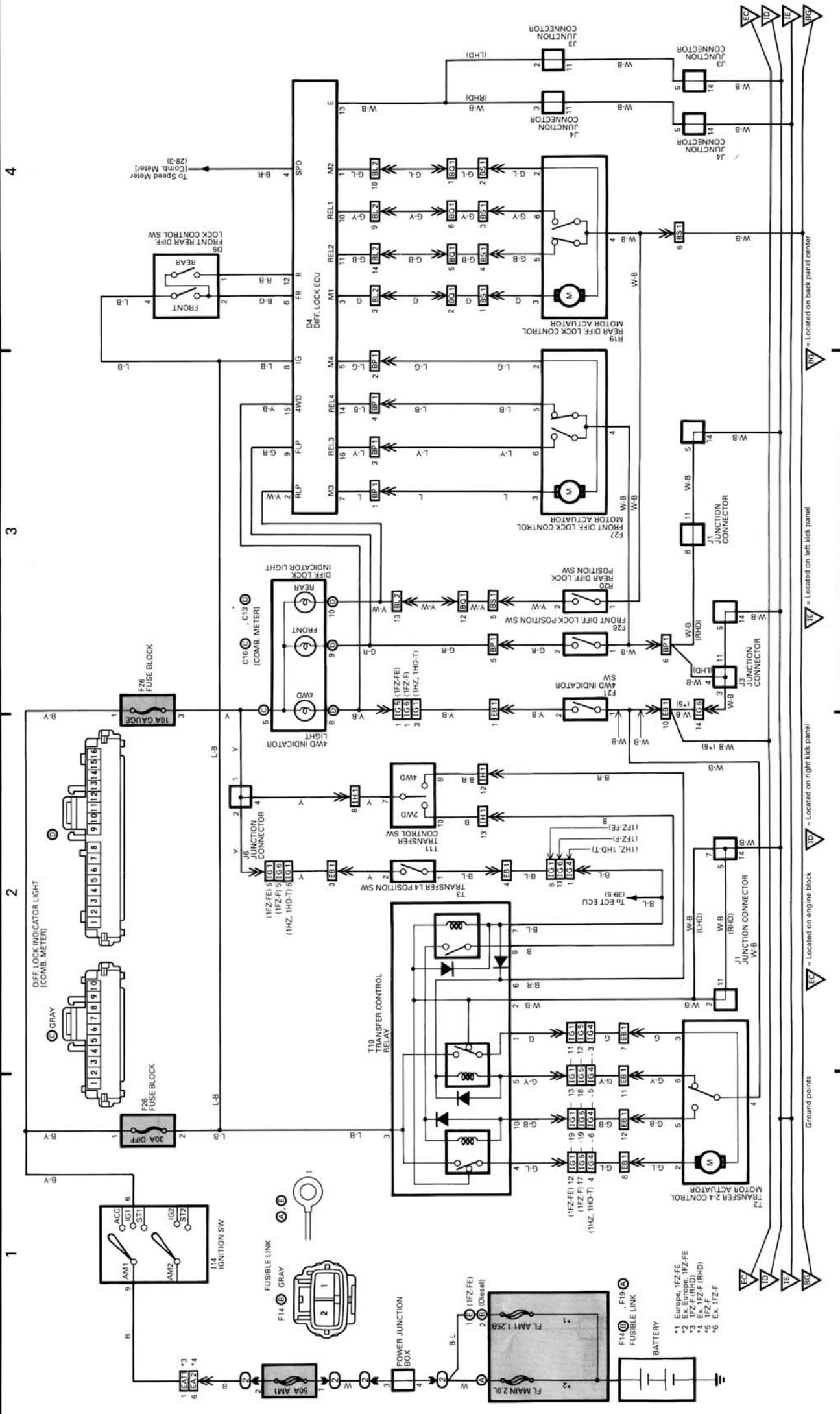

- \* 1 Engine, 1FZ-FE
- \* 2 Diesel, 1FZ-FE
- \* 3 1FZ-F (RHD)
- \* 4 Ex. 1FZ-F (RHD)
- \* 5 1FZ-F (LHD)
- \* 6 Ex. 1FZ-F

EC1 = Located on engine block    EC2 = Located on right kick panel    EC3 = Located on left kick panel    EC4 = Located on back panel center



Power Source



Cruise Control

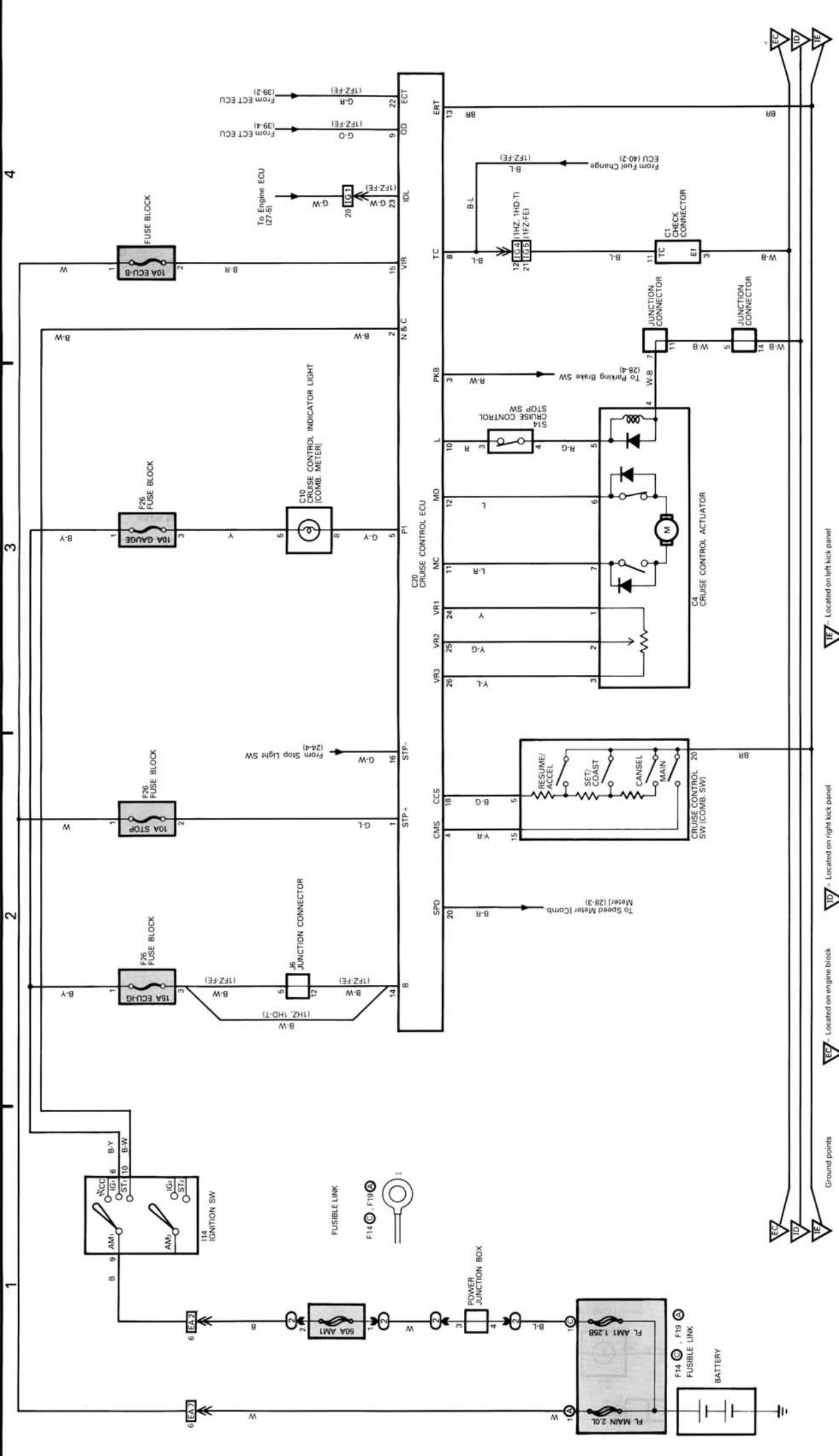

Ground points

EC1 Located on engine block

ID1 Located on right kick panel

IE1 Located on left kick panel



# 24 LAND CRUISER (W/G)

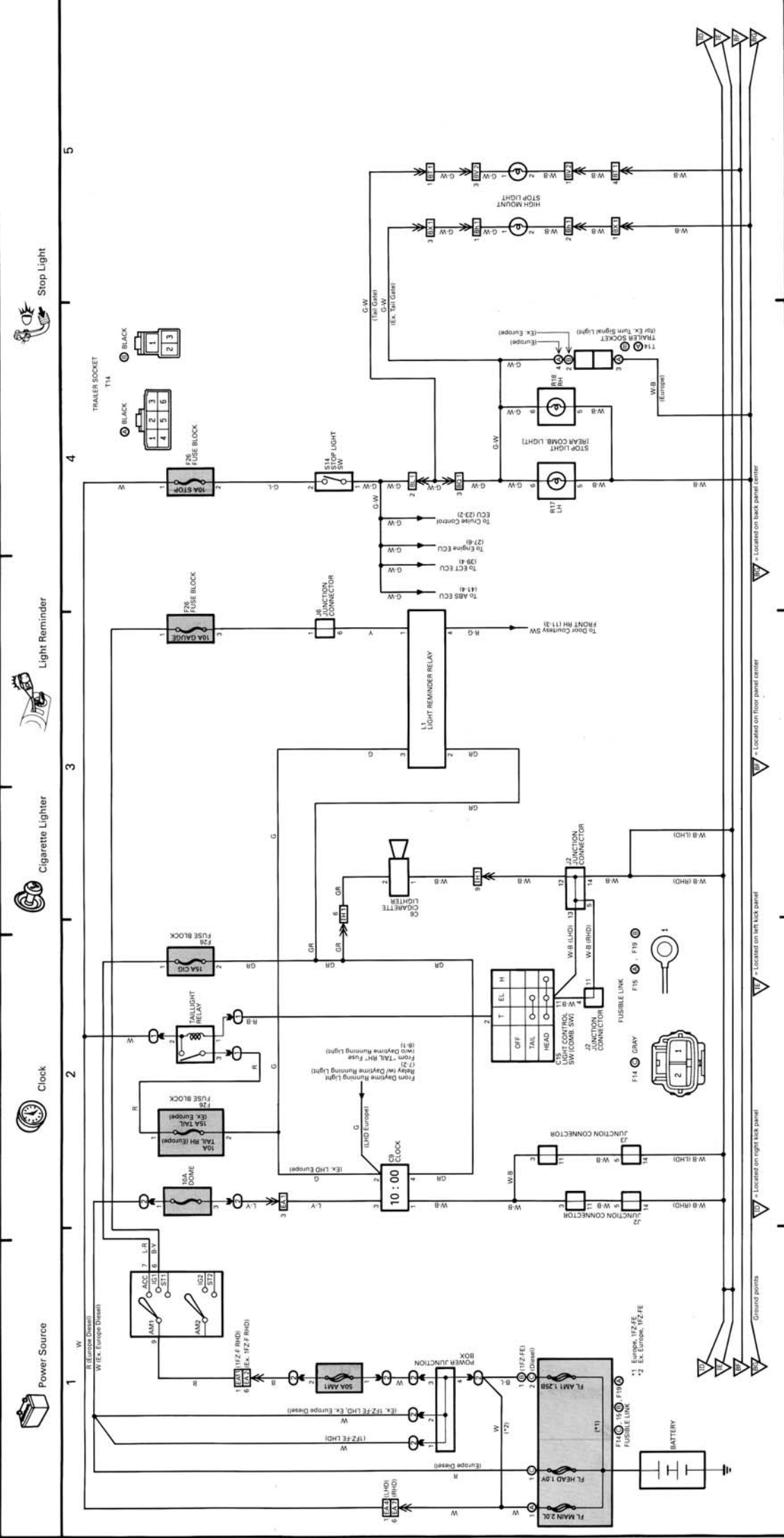

Ground points

⚡ = Located on right kick panel

⚡ = Located on floor panel center

⚡ = Located on back panel center

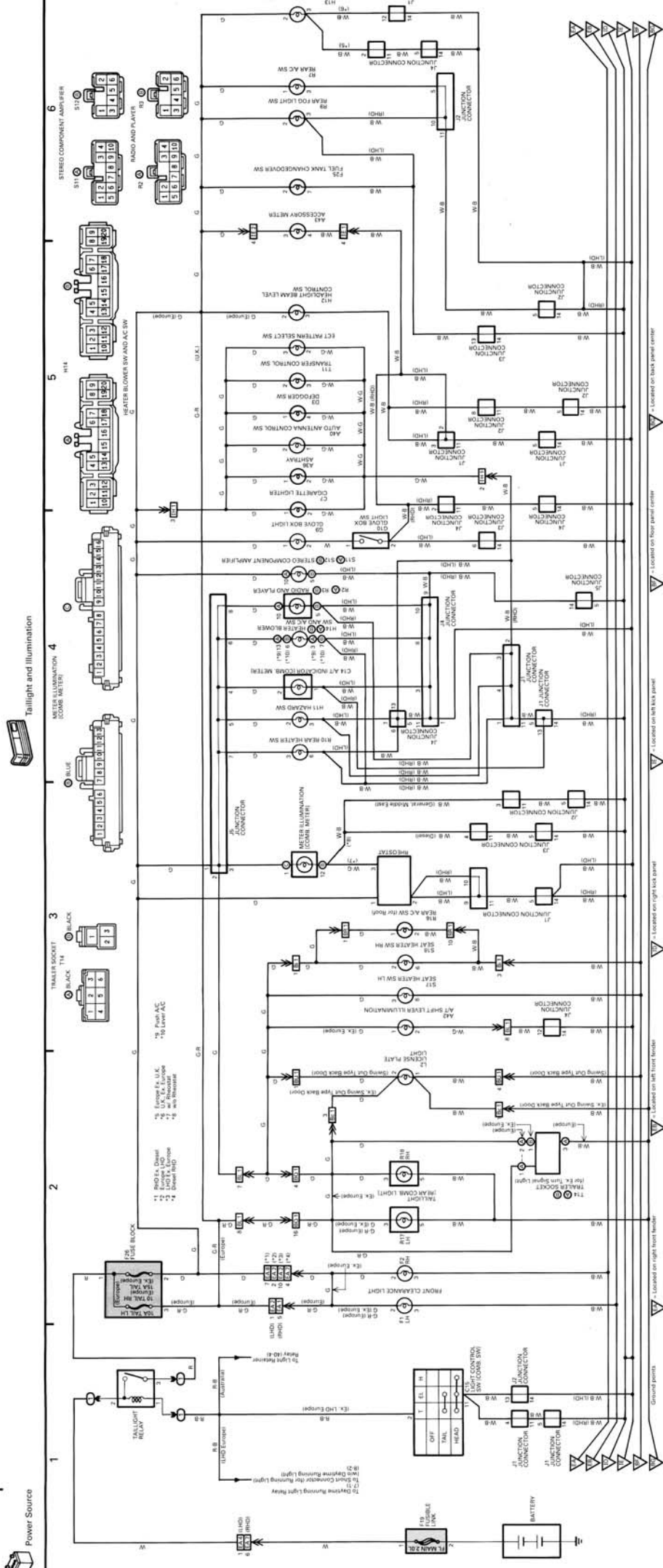

Tailight and Illumination

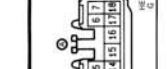

Power Source



MAIN 20A FUSE

TAILIGHT RELAY

TO LIGHT RELAY

TO LIGHT RELAY

TO LIGHT RELAY

TO LIGHT RELAY

TO LIGHT RELAY

TO LIGHT RELAY

TO LIGHT RELAY

TO LIGHT RELAY

TO LIGHT RELAY

TO LIGHT RELAY

TO LIGHT RELAY

TO LIGHT RELAY

TO LIGHT RELAY

TO LIGHT RELAY

TO LIGHT RELAY

TO LIGHT RELAY

1. Black AC  
2. L.U.V. & Europe  
3. Smart LED  
4. 5. 6. 7. 8. 9. 10. 11. 12. 13. 14. 15. 16. 17. 18. 19. 20. 21. 22. 23. 24. 25. 26. 27. 28. 29. 30. 31. 32. 33. 34. 35. 36. 37. 38. 39. 40. 41. 42. 43. 44. 45. 46. 47. 48. 49. 50. 51. 52. 53. 54. 55. 56. 57. 58. 59. 60. 61. 62. 63. 64. 65. 66. 67. 68. 69. 70. 71. 72. 73. 74. 75. 76. 77. 78. 79. 80. 81. 82. 83. 84. 85. 86. 87. 88. 89. 90. 91. 92. 93. 94. 95. 96. 97. 98. 99. 100. 101. 102. 103. 104. 105. 106. 107. 108. 109. 110. 111. 112. 113. 114. 115. 116. 117. 118. 119. 120. 121. 122. 123. 124. 125. 126. 127. 128. 129. 130. 131. 132. 133. 134. 135. 136. 137. 138. 139. 140. 141. 142. 143. 144. 145. 146. 147. 148. 149. 150. 151. 152. 153. 154. 155. 156. 157. 158. 159. 160. 161. 162. 163. 164. 165. 166. 167. 168. 169. 170. 171. 172. 173. 174. 175. 176. 177. 178. 179. 180. 181. 182. 183. 184. 185. 186. 187. 188. 189. 190. 191. 192. 193. 194. 195. 196. 197. 198. 199. 200. 201. 202. 203. 204. 205. 206. 207. 208. 209. 210. 211. 212. 213. 214. 215. 216. 217. 218. 219. 220. 221. 222. 223. 224. 225. 226. 227. 228. 229. 230. 231. 232. 233. 234. 235. 236. 237. 238. 239. 240. 241. 242. 243. 244. 245. 246. 247. 248. 249. 250. 251. 252. 253. 254. 255. 256. 257. 258. 259. 260. 261. 262. 263. 264. 265. 266. 267. 268. 269. 270. 271. 272. 273. 274. 275. 276. 277. 278. 279. 280. 281. 282. 283. 284. 285. 286. 287. 288. 289. 290. 291. 292. 293. 294. 295. 296. 297. 298. 299. 300. 301. 302. 303. 304. 305. 306. 307. 308. 309. 310. 311. 312. 313. 314. 315. 316. 317. 318. 319. 320. 321. 322. 323. 324. 325. 326. 327. 328. 329. 330. 331. 332. 333. 334. 335. 336. 337. 338. 339. 340. 341. 342. 343. 344. 345. 346. 347. 348. 349. 350. 351. 352. 353. 354. 355. 356. 357. 358. 359. 360. 361. 362. 363. 364. 365. 366. 367. 368. 369. 370. 371. 372. 373. 374. 375. 376. 377. 378. 379. 380. 381. 382. 383. 384. 385. 386. 387. 388. 389. 390. 391. 392. 393. 394. 395. 396. 397. 398. 399. 400. 401. 402. 403. 404. 405. 406. 407. 408. 409. 410. 411. 412. 413. 414. 415. 416. 417. 418. 419. 420. 421. 422. 423. 424. 425. 426. 427. 428. 429. 430. 431. 432. 433. 434. 435. 436. 437. 438. 439. 440. 441. 442. 443. 444. 445. 446. 447. 448. 449. 450. 451. 452. 453. 454. 455. 456. 457. 458. 459. 460. 461. 462. 463. 464. 465. 466. 467. 468. 469. 470. 471. 472. 473. 474. 475. 476. 477. 478. 479. 480. 481. 482. 483. 484. 485. 486. 487. 488. 489. 490. 491. 492. 493. 494. 495. 496. 497. 498. 499. 500. 501. 502. 503. 504. 505. 506. 507. 508. 509. 510. 511. 512. 513. 514. 515. 516. 517. 518. 519. 520. 521. 522. 523. 524. 525. 526. 527. 528. 529. 530. 531. 532. 533. 534. 535. 536. 537. 538. 539. 540. 541. 542. 543. 544. 545. 546. 547. 548. 549. 550. 551. 552. 553. 554. 555. 556. 557. 558. 559. 560. 561. 562. 563. 564. 565. 566. 567. 568. 569. 570. 571. 572. 573. 574. 575. 576. 577. 578. 579. 580. 581. 582. 583. 584. 585. 586. 587. 588. 589. 590. 591. 592. 593. 594. 595. 596. 597. 598. 599. 600. 601. 602. 603. 604. 605. 606. 607. 608. 609. 610. 611. 612. 613. 614. 615. 616. 617. 618. 619. 620. 621. 622. 623. 624. 625. 626. 627. 628. 629. 630. 631. 632. 633. 634. 635. 636. 637. 638. 639. 640. 641. 642. 643. 644. 645. 646. 647. 648. 649. 650. 651. 652. 653. 654. 655. 656. 657. 658. 659. 660. 661. 662. 663. 664. 665. 666. 667. 668. 669. 670. 671. 672. 673. 674. 675. 676. 677. 678. 679. 680. 681. 682. 683. 684. 685. 686. 687. 688. 689. 690. 691. 692. 693. 694. 695. 696. 697. 698. 699. 700. 701. 702. 703. 704. 705. 706. 707. 708. 709. 710. 711. 712. 713. 714. 715. 716. 717. 718. 719. 720. 721. 722. 723. 724. 725. 726. 727. 728. 729. 730. 731. 732. 733. 734. 735. 736. 737. 738. 739. 740. 741. 742. 743. 744. 745. 746. 747. 748. 749. 750. 751. 752. 753. 754. 755. 756. 757. 758. 759. 760. 761. 762. 763. 764. 765. 766. 767. 768. 769. 770. 771. 772. 773. 774. 775. 776. 777. 778. 779. 780. 781. 782. 783. 784. 785. 786. 787. 788. 789. 790. 791. 792. 793. 794. 795. 796. 797. 798. 799. 800. 801. 802. 803. 804. 805. 806. 807. 808. 809. 810. 811. 812. 813. 814. 815. 816. 817. 818. 819. 820. 821. 822. 823. 824. 825. 826. 827. 828. 829. 830. 831. 832. 833. 834. 835. 836. 837. 838. 839. 840. 841. 842. 843. 844. 845. 846. 847. 848. 849. 850. 851. 852. 853. 854. 855. 856. 857. 858. 859. 860. 861. 862. 863. 864. 865. 866. 867. 868. 869. 870. 871. 872. 873. 874. 875. 876. 877. 878. 879. 880. 881. 882. 883. 884. 885. 886. 887. 888. 889. 890. 891. 892. 893. 894. 895. 896. 897. 898. 899. 900. 901. 902. 903. 904. 905. 906. 907. 908. 909. 910. 911. 912. 913. 914. 915. 916. 917. 918. 919. 920. 921. 922. 923. 924. 925. 926. 927. 928. 929. 930. 931. 932. 933. 934. 935. 936. 937. 938. 939. 940. 941. 942. 943. 944. 945. 946. 947. 948. 949. 950. 951. 952. 953. 954. 955. 956. 957. 958. 959. 960. 961. 962. 963. 964. 965. 966. 967. 968. 969. 970. 971. 972. 973. 974. 975. 976. 977. 978. 979. 980. 981. 982. 983. 984. 985. 986. 987. 988. 989. 990. 991. 992. 993. 994. 995. 996. 997. 998. 999. 1000.

USA

UK

Europe

Japan

Ground points

1. Located on right front fender

2. Located on left front fender

3. Located on right lock panel

4. Located on left lock panel

5. Located on rear panel center

6. Located on back panel center

7. Located on right front fender

8. Located on left front fender

9. Located on right lock panel

10. Located on left lock panel

11. Located on rear panel center

12. Located on back panel center

13. Located on right front fender

14. Located on left front fender

15. Located on right lock panel

16. Located on left lock panel

26 LAND CRUISER (W/G)

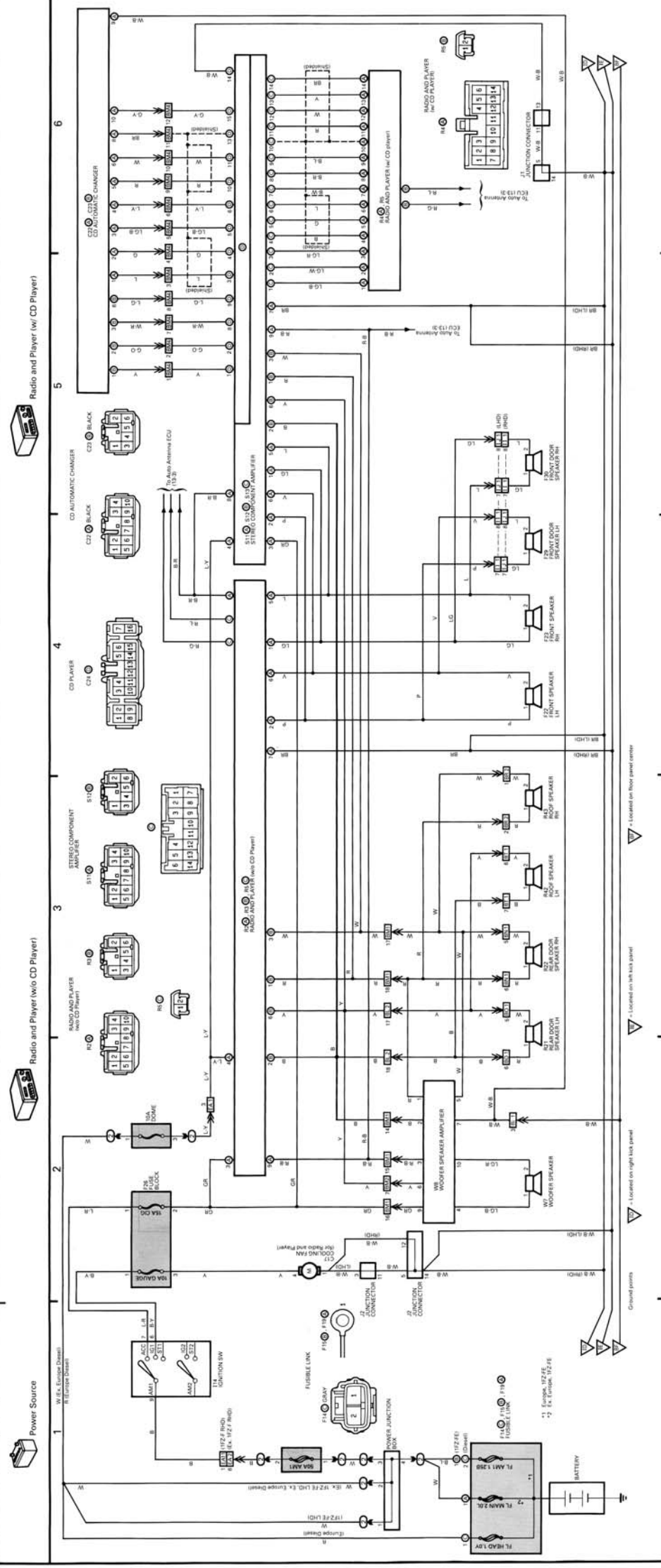

1: 1457 Engine Assembly  
2: 1458 Fuel System



Power Source



Engine Control

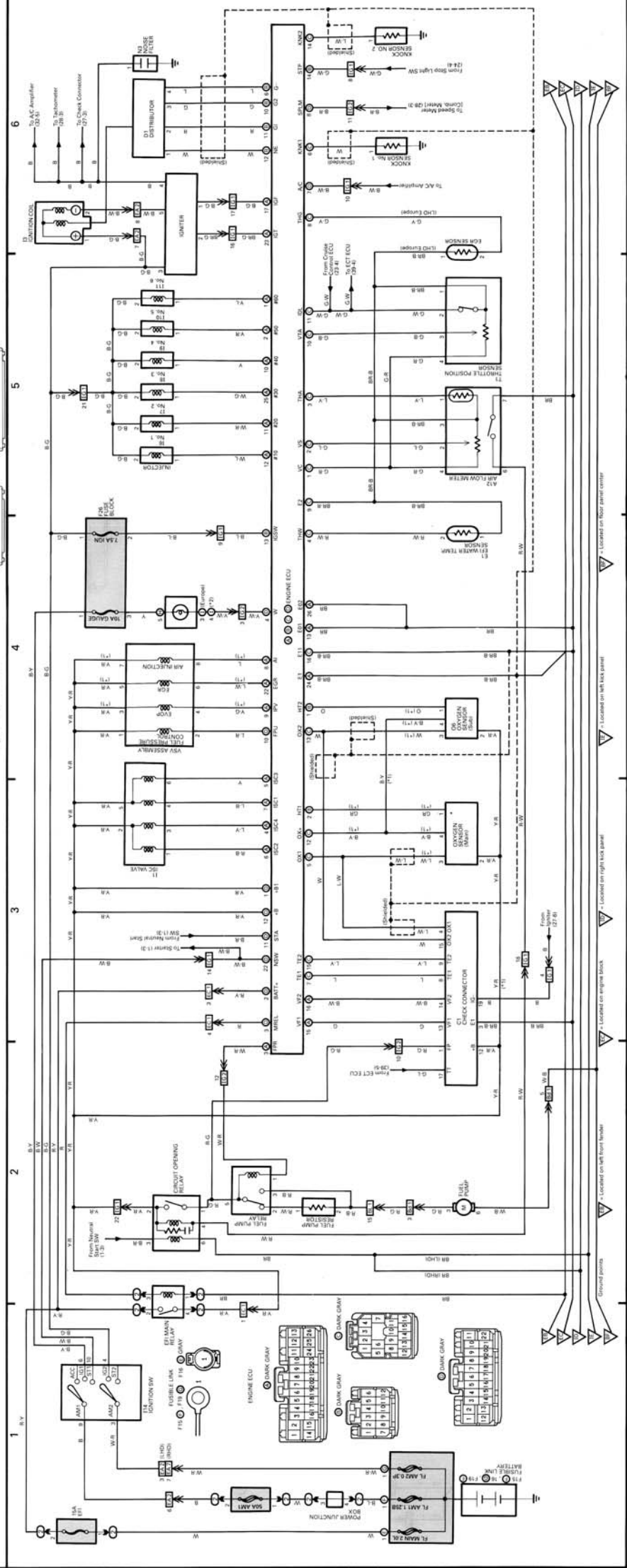

5  
CHECK ENGINE WARNING LIGHT (1457)  
MILEAGE METER (1458)  
OIL PRESSURE GAUGE (1459)



4  
IGNITION LOCK (1460)



3  
FUEL GAUGE (1461)



2  
IGNITION SWITCH (1462)



6  
IGNITION SWITCH (1462)

Ground points: 1. Located on left fender, 2. Located on engine block, 3. Located on right fender, 4. Located on left fender, 5. Located on floor panel center, 6. Located on right fender.

28 LAND CRUISER (W/G)

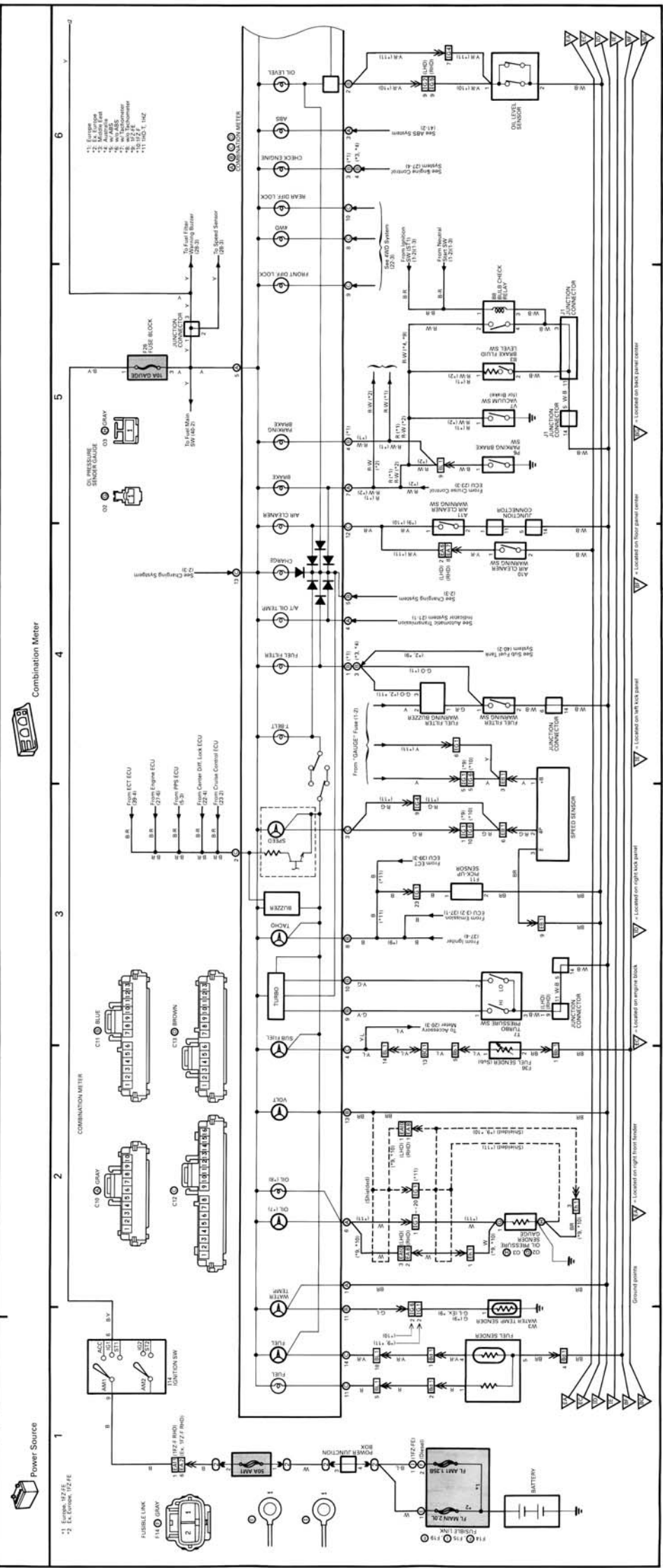

- 1: Engine
- 2: ECU
- 3: ABS
- 4: ABS SYSTEM CONTROL
- 5: Oil Pressure Sensor
- 6: Oil Level Sensor
- 7: Water Temperature Sensor
- 8: Fuel Temperature Sensor
- 9: Turbine Oil Temperature Sensor
- 10: Check Engine Control
- 11: Rear Defog Lock



Ground points

1 - Located on right-hand member

2 - Located on engine block

3 - Located on right-hand panel

4 - Located on left-hand panel

5 - Located on floor panel center

6 - Located on back panel center



Fuel Tank Changeover



Combination Meter

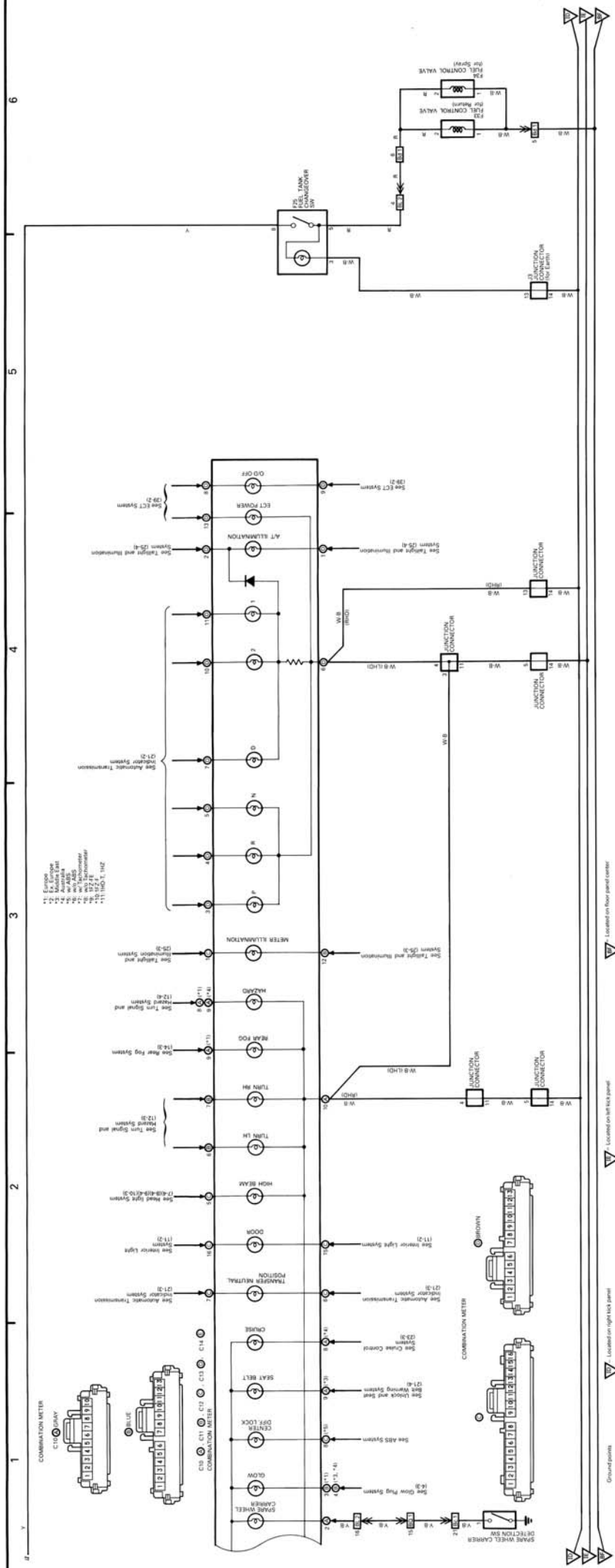

Ground points

Located on floor panel center

Located on left side panel

Located on right side panel

30 LAND CRUISER (W/G)

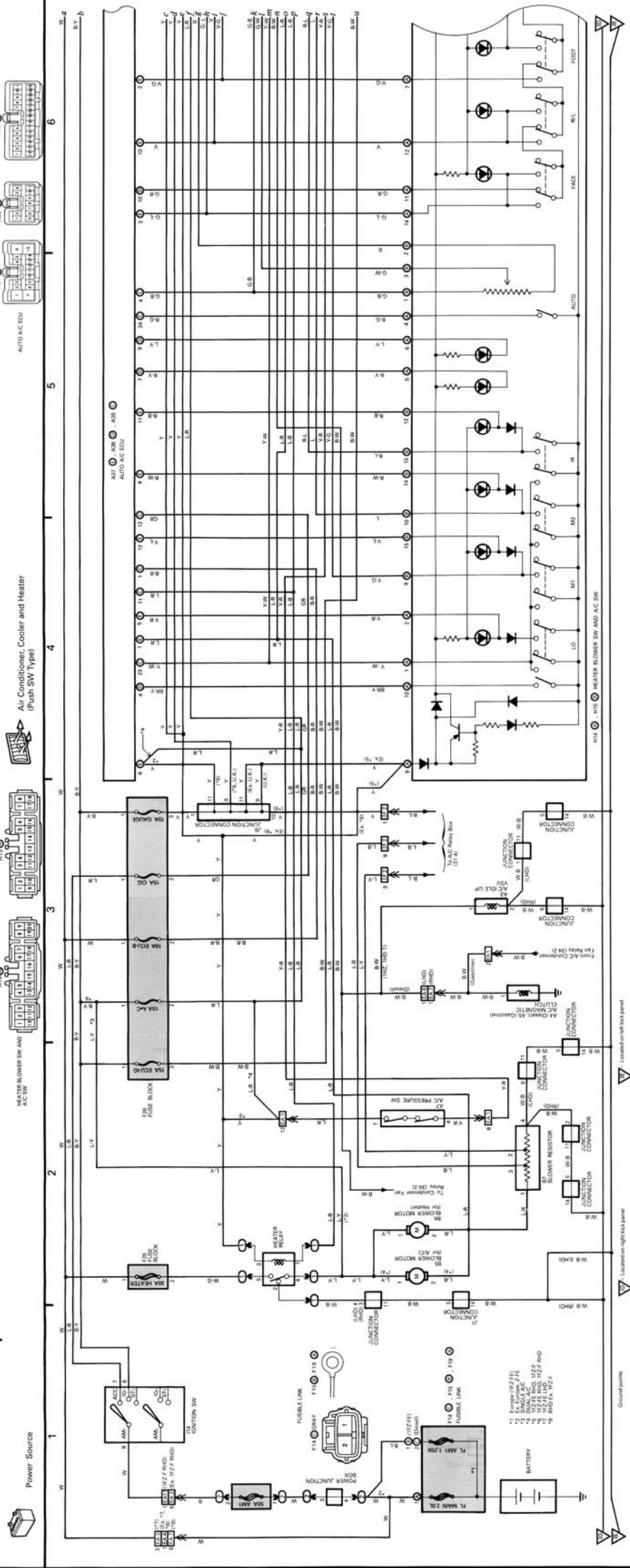

Air Conditioner, Cooler and Heater (Push SW Type)



- \*1 BATTERY (12V 65)
- \*2 5A BATTERY FUSE
- \*3 10A BATTERY FUSE
- \*4 DUAL A/C 100V 152F 100V
- \*5 100V 152F 100V
- \*6 100V 152F 100V
- \*7 100V 152F 100V
- \*8 100V 152F 100V

Located on left side panel

Ground points

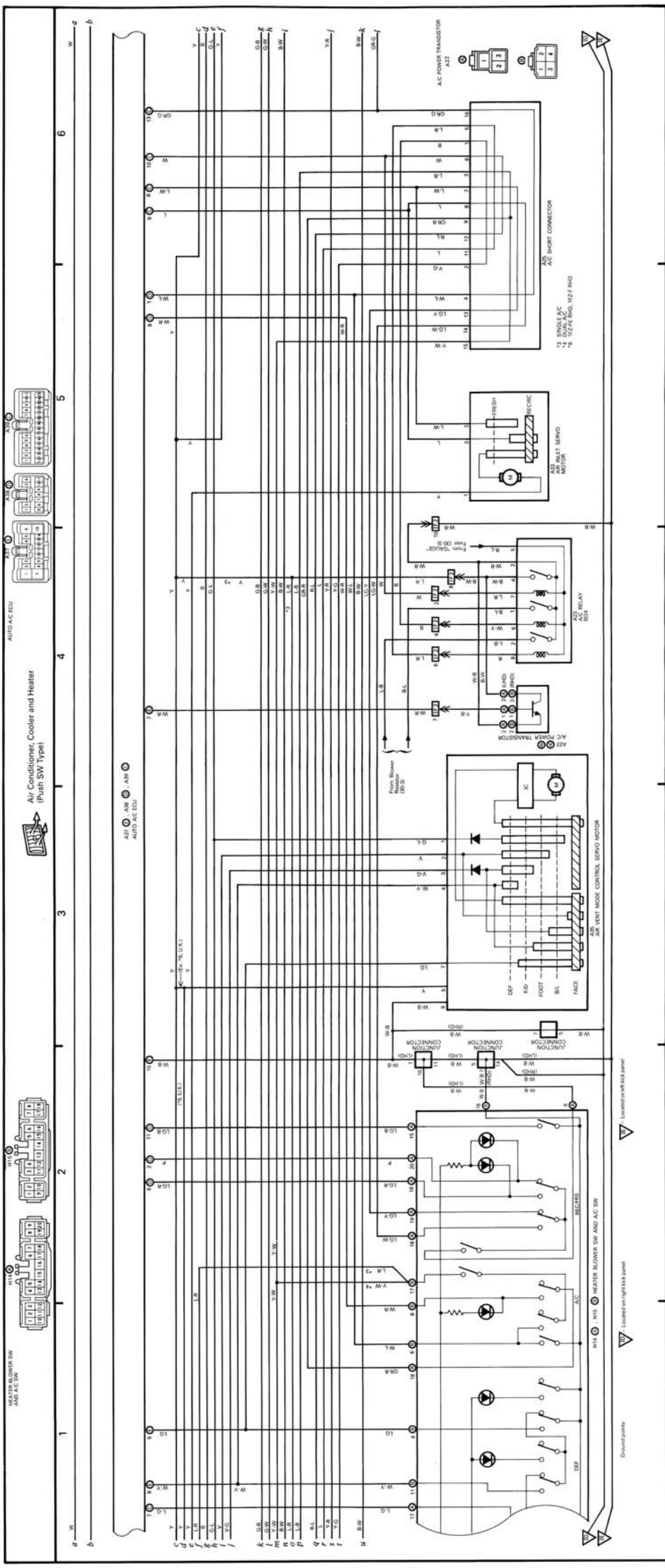



32 LAND CRUISER (W/G)

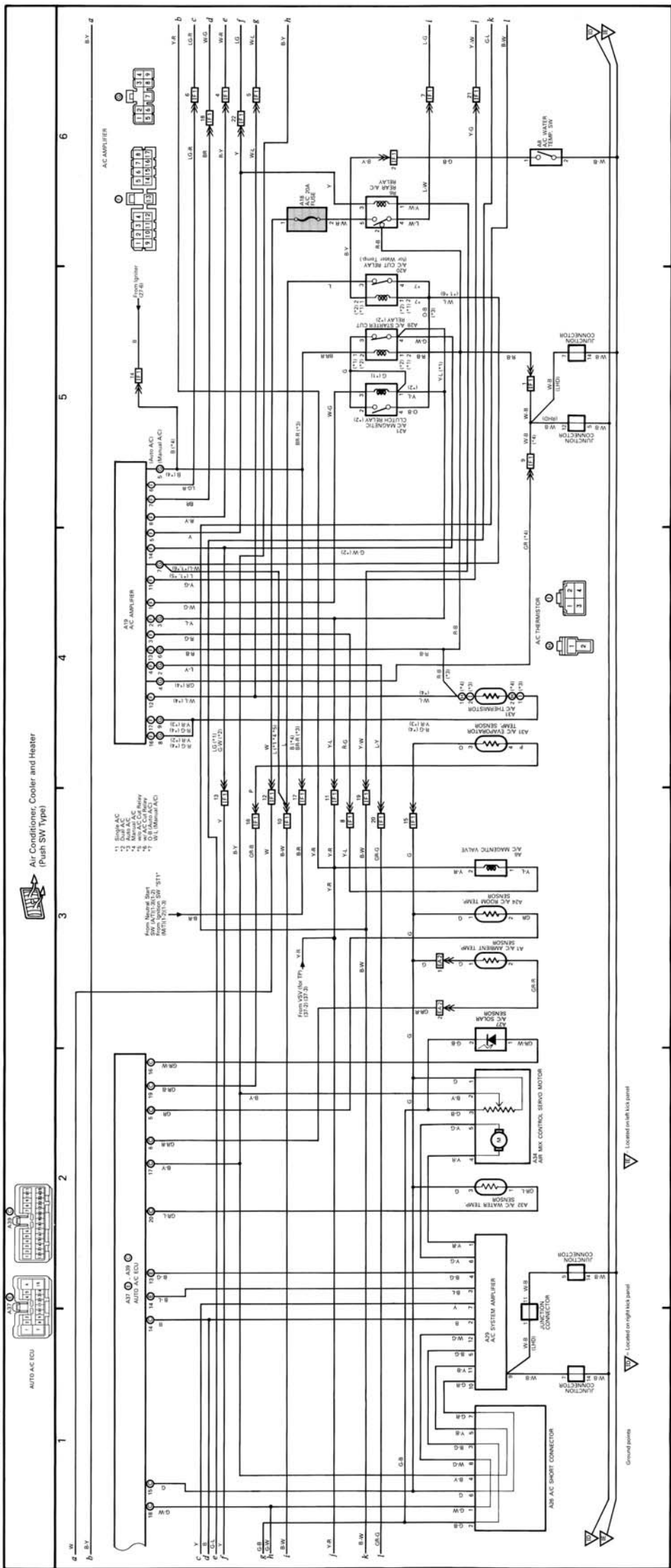

Air Conditioner, Cooler and Heater  
(Push SW Type)

1  
2  
3  
4  
5  
6

Auto A/C ECU

AC AMPLIFIER

A37 A39 AUTO A/C ECU

A32 A/C SYSTEM AMP

A30 A/C WAX CONTROL SERVO MOTOR

A31 A/C THERMISTOR

1  
2  
3  
4  
5  
6

Auto A/C ECU

AC AMPLIFIER

A37 A39 AUTO A/C ECU

A32 A/C SYSTEM AMP

A30 A/C WAX CONTROL SERVO MOTOR

A31 A/C THERMISTOR



# 34 LAND CRUISER (W/G)

## Air Conditioner, Cooler and Heater (Manual Dual A/C Type)

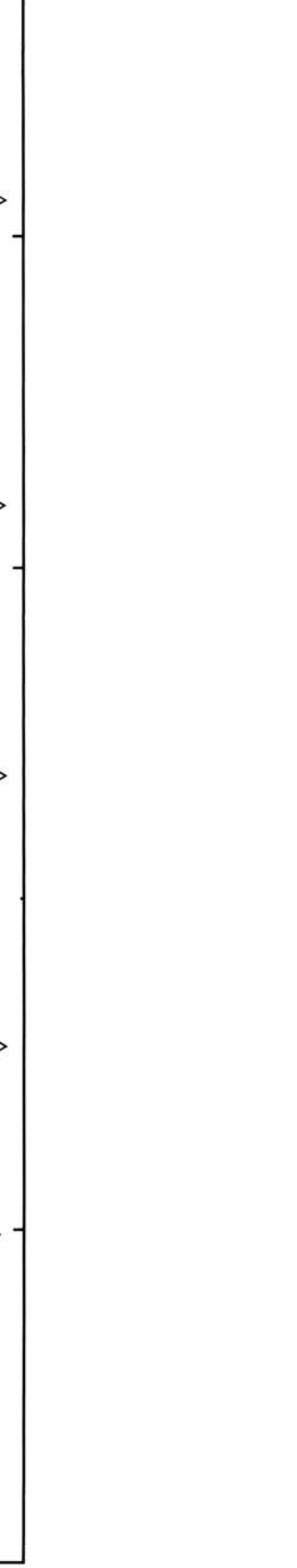
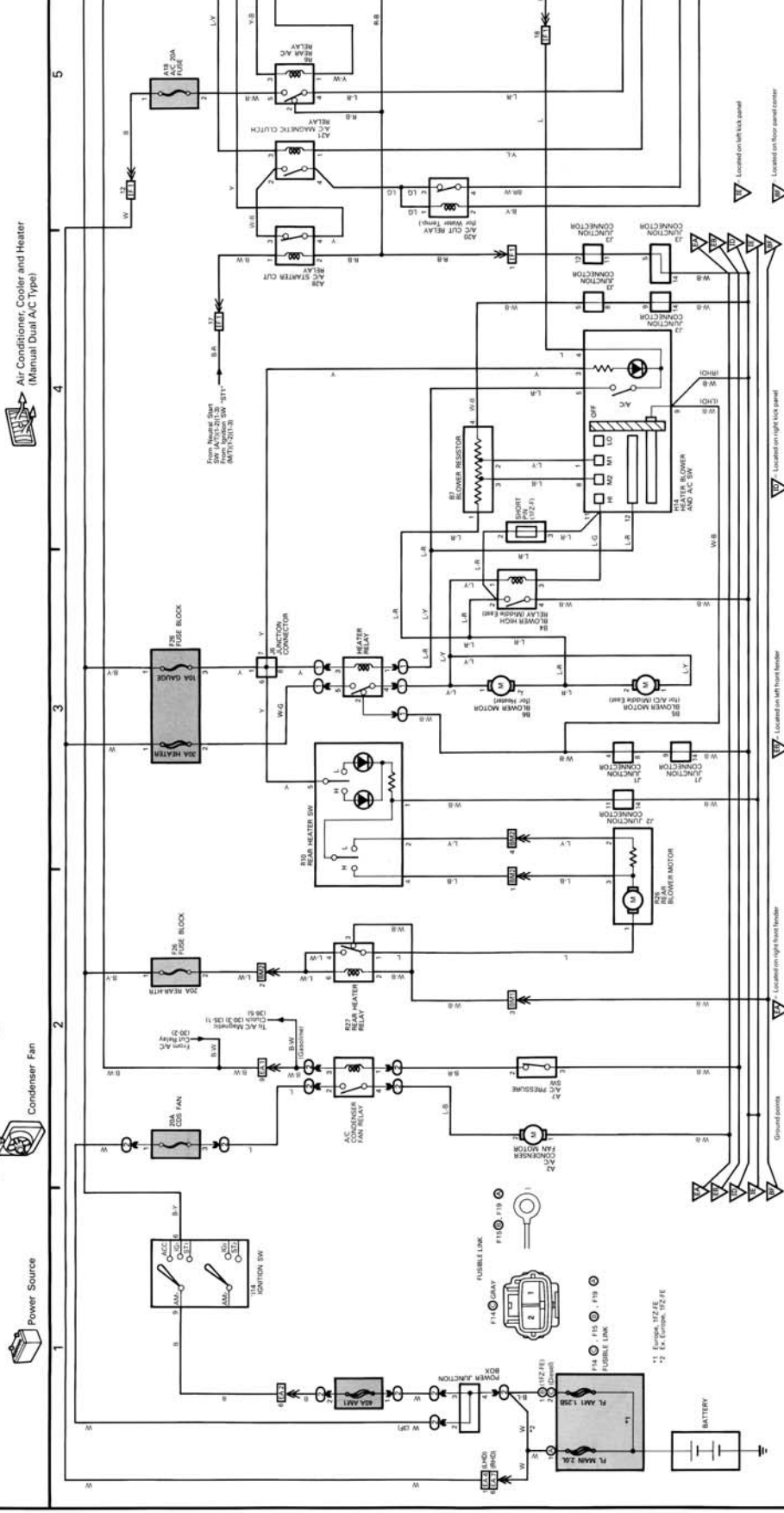

Ground points  
1: Located on right hand fender  
2: Located on left hand fender  
3: Located on left front bumper  
4: Located on right lock panel  
5: Located on left lock panel  
6: Located on floor panel center



Air Conditioner, Cooler and Heater (Manual Dual A/C Type)



Rear Air Conditioner (Manual)

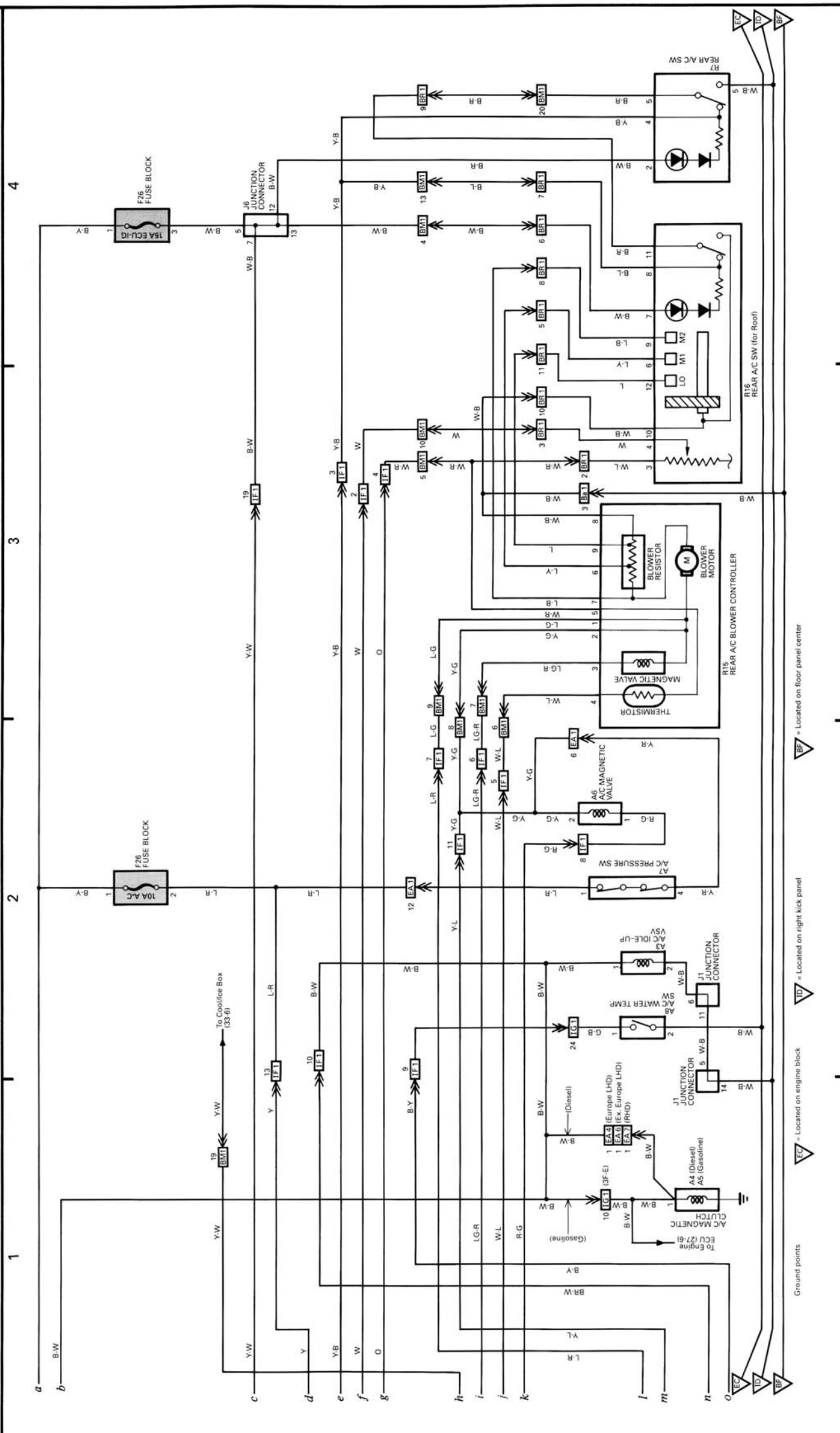

36 LAND CRUISER (W/G)

Air Conditioner, Cooler and Heater  
(Manual Single A/C Lever SW Type)

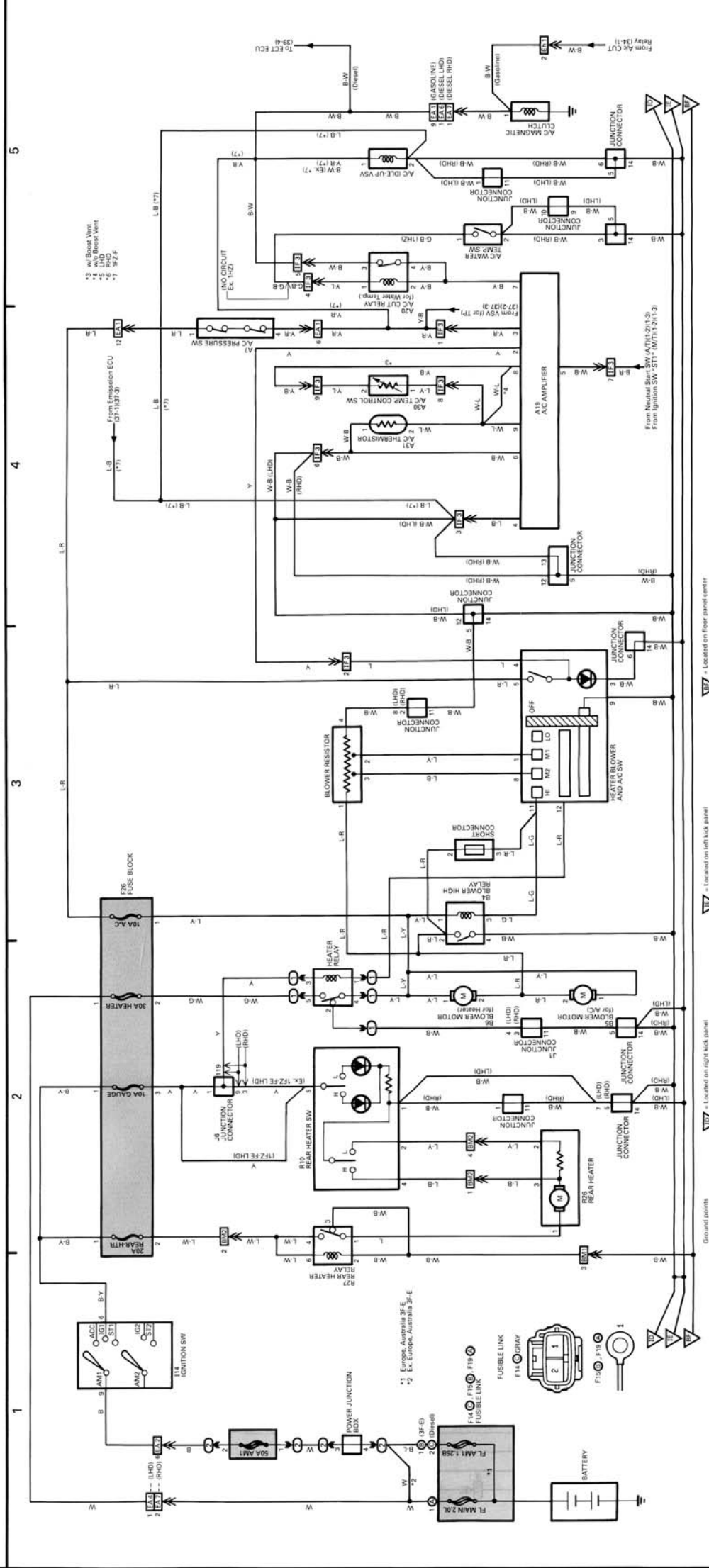

- \*3 w/ Boost Vent
- \*4 w/o Boost Vent
- \*5 RHD
- \*6 LHD
- \*7 JFZF

- \*1 Europe, Australia 3F-E
- \*2 Ex. Europe, Australia 3F-E

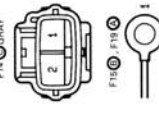

Ground points

↳ Located on right lock panel

↳ Located on left lock panel

↳ Located on floor panel center

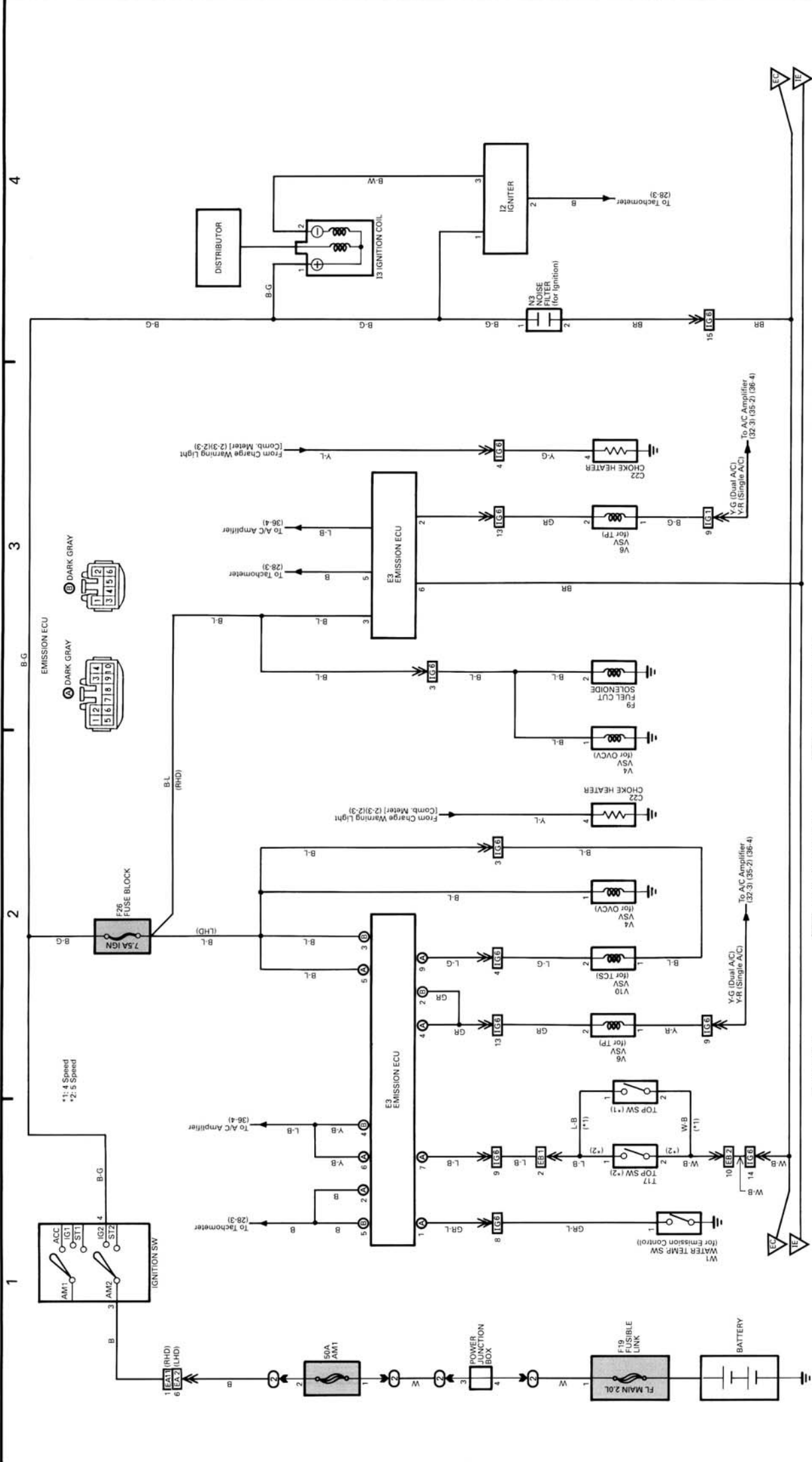

# 38 LAND CRUISER (W/G)



Power Source



Front Wiper and Washer (1FZ-FE, 1FZ-F)



Rear Wiper and Washer (1FZ-FE, 1FZ-F)

1 2 3 4

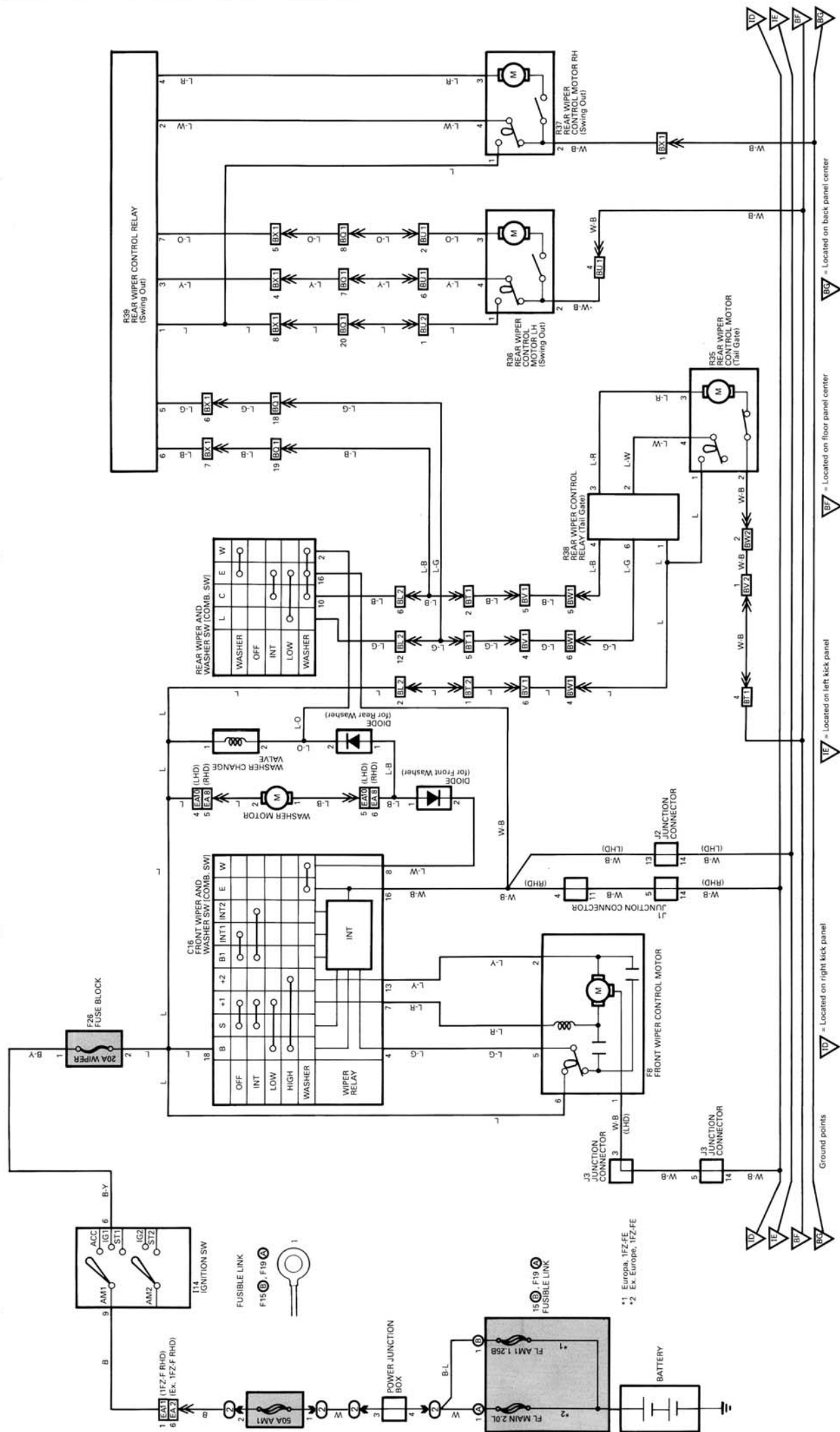

\*1 Europe, 1FZ-FE  
\*2 Ex Europe, 1FZ-FE

Ground points  
ID - Located on right kick panel  
IE - Located on left kick panel  
IF - Located on floor panel center  
IG - Located on back panel center

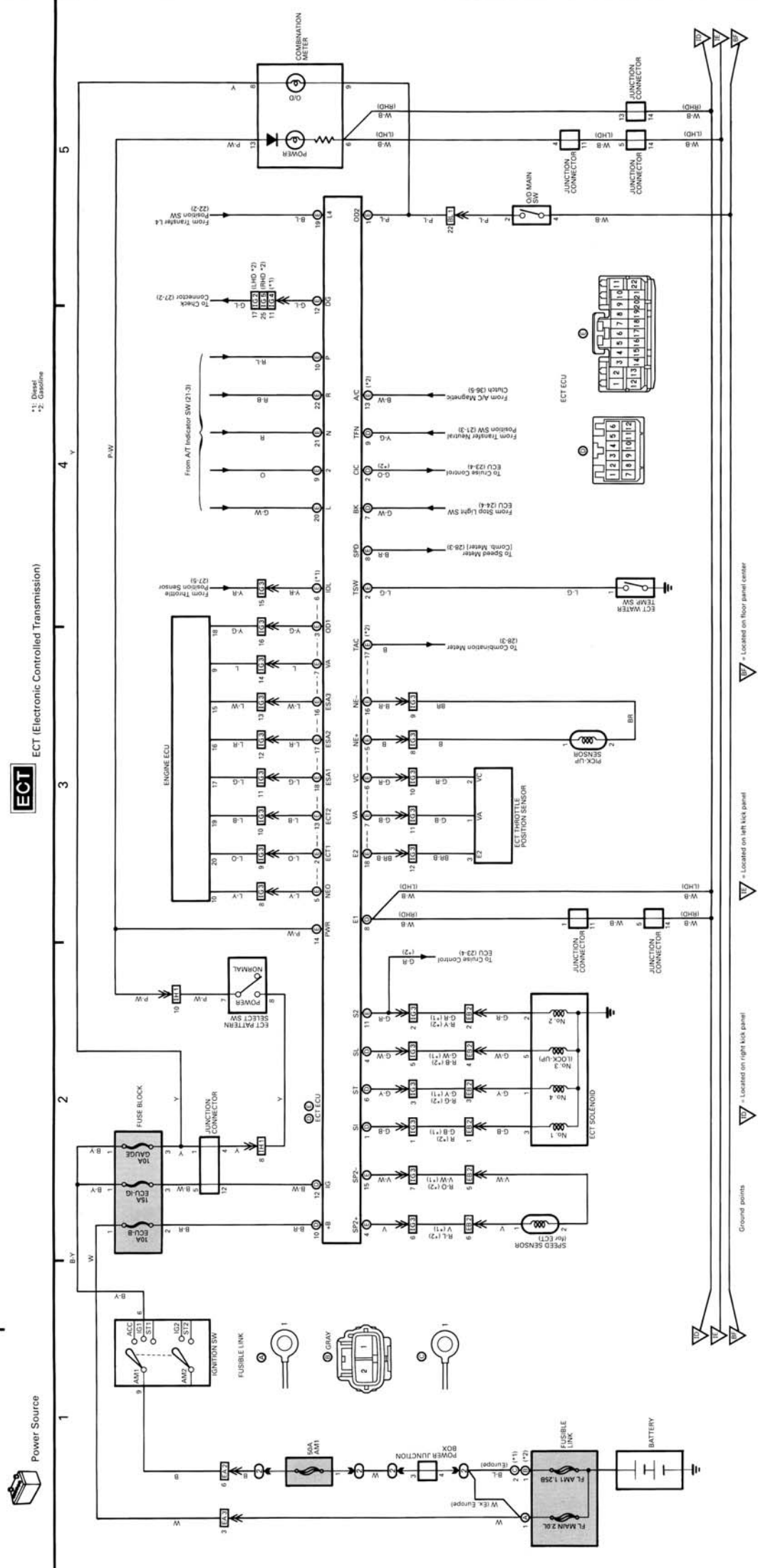

ECT (Electronic Controlled Transmission)



# 40 LAND CRUISER (W/G)



Power Source



Sub Fuel Tank (1FZ-FE)



Light Auto Turn Off

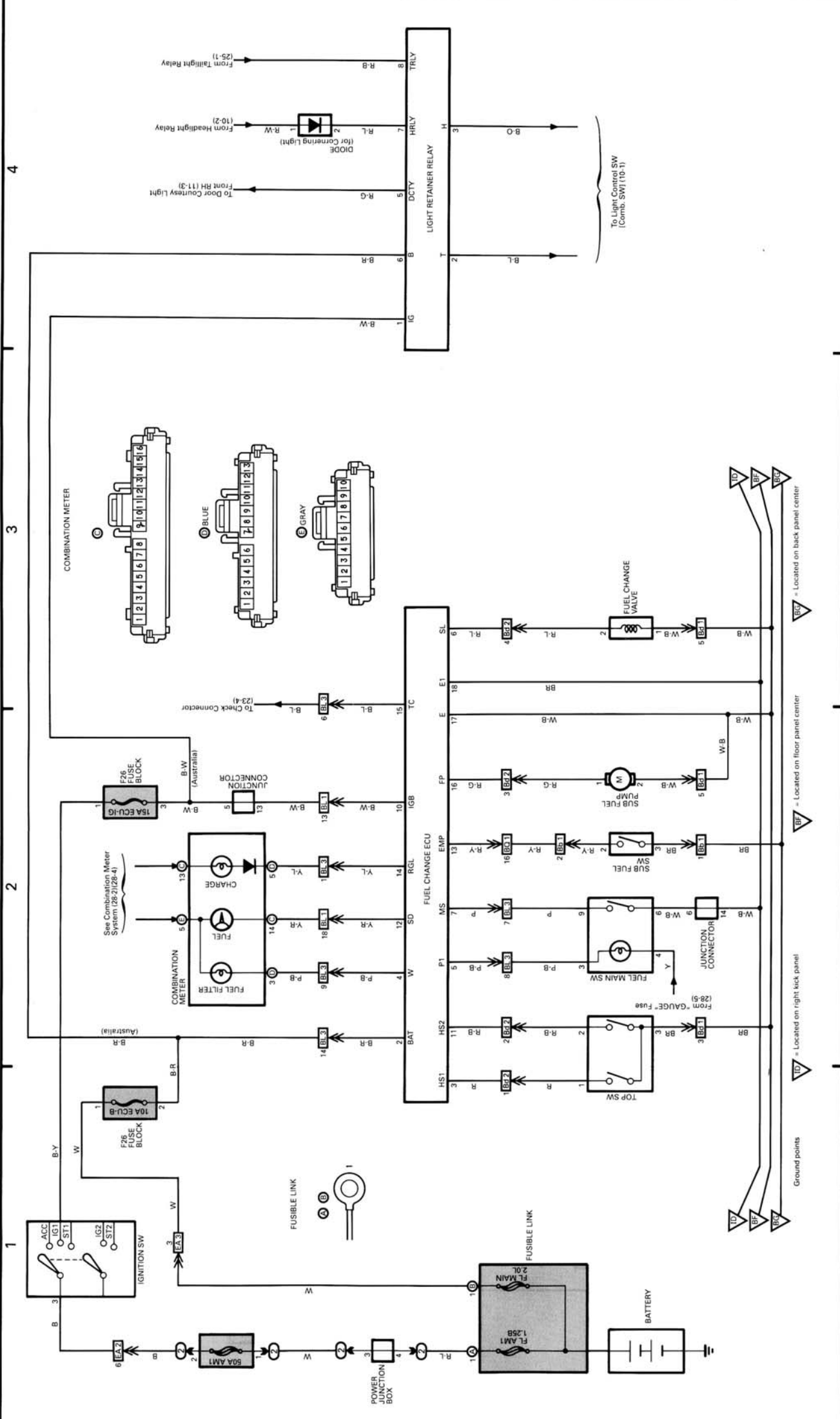

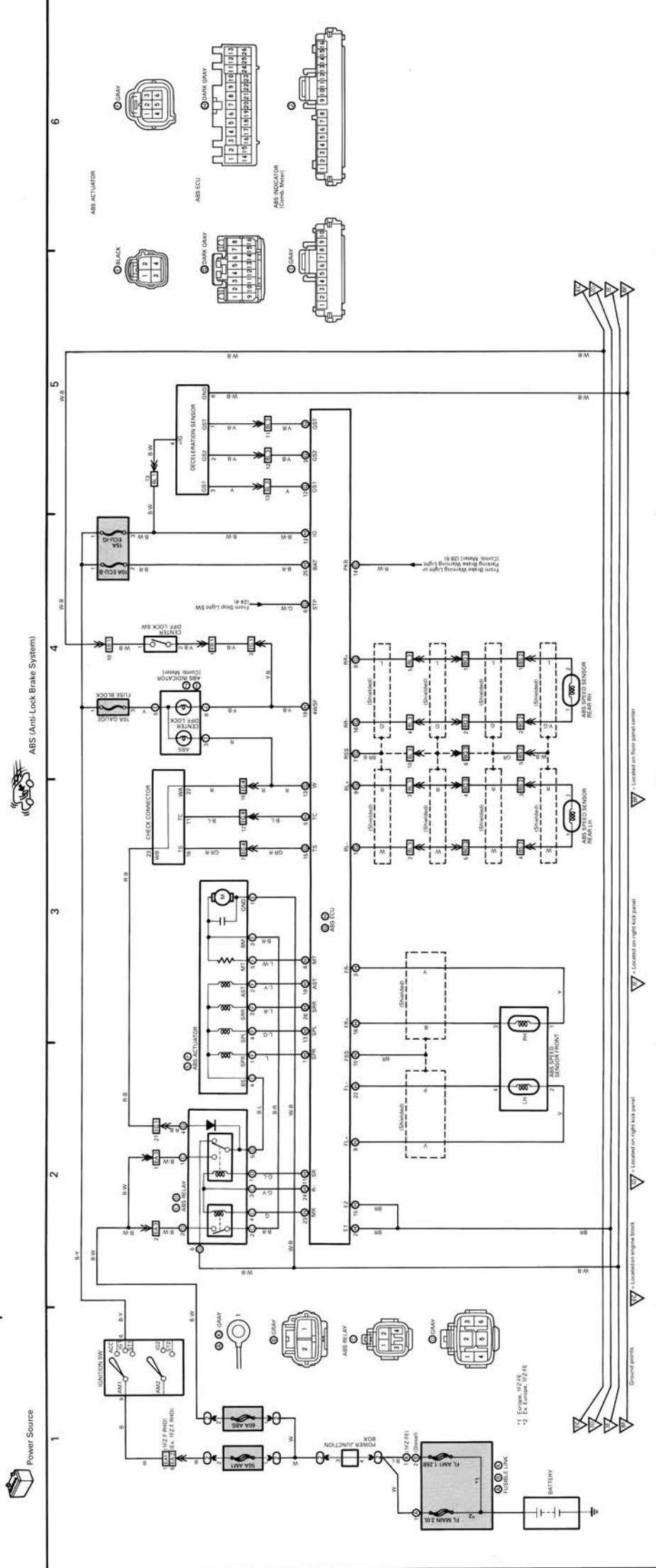

**Connector Joining Wire Harness and Wire Harness  
(E Group: Engine Compartment Area)**

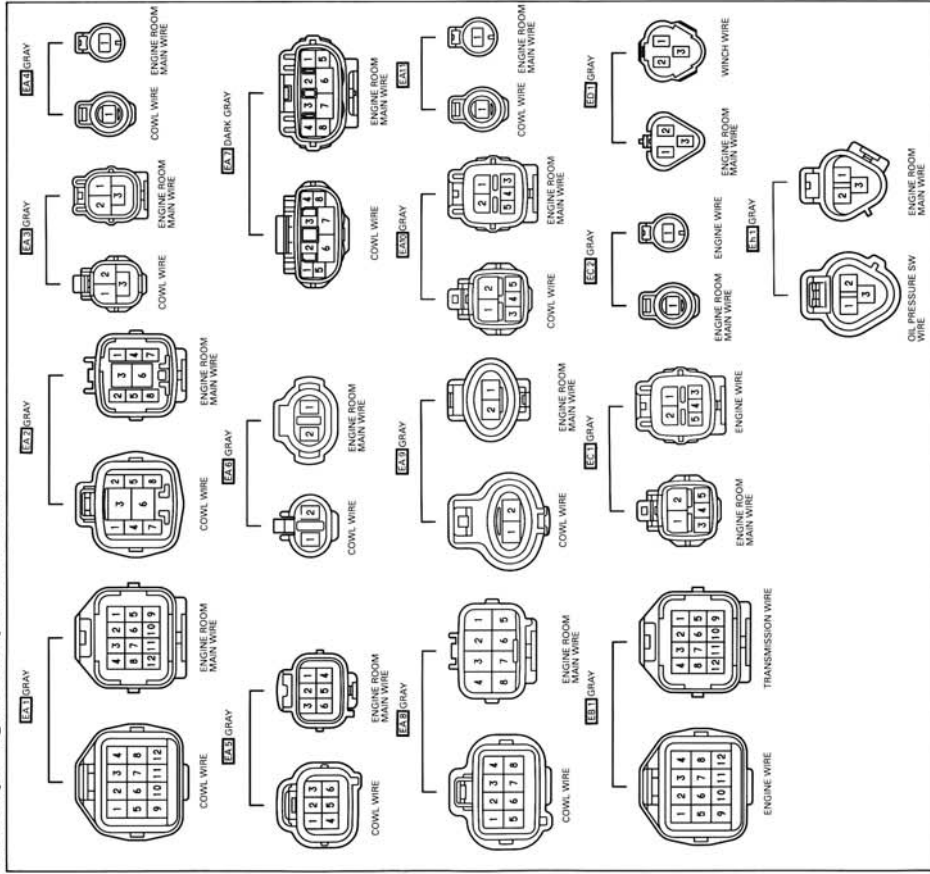

**(I Group: Instrument Panel and Surrounding Area)**

